



NVH220

LOPHIUS AI

Handheld Scanner

Disclaimer

© 2023 Newland Europe BV. All rights reserved.

Please read the manual carefully before using the product and operate it according to the manual. It is advised that you keep this manual for future reference.

Do not disassemble the device or remove the seal label from the device; doing so will void the product warranty provided by Newland Europe BV.

All pictures in this manual are for reference only, and the actual product may differ.

Regarding product modification and update, Newland Europe BV reserves the right to make changes to any software or hardware to improve reliability, function, or design at any time without notice. The information contained herein is subject to change without prior notice.

The products depicted in this manual may include software copyrighted by Newland Europe BV or a third party. The user, corporation or individual shall not duplicate, in whole or in part, distribute, modify, decompile, disassemble, decode, reverse engineer, rent, transfer, or sublicense such software without prior written consent from the copyright holders.

This manual is copyrighted. No part of this publication may be reproduced, distributed, or used in any form without Newland Europe BV's written permission.

Risk Warning Regarding Unauthorized System Updates:

You should use the Newland-provided tool to update this product's system. Modifying system files by installing a third-party ROM system or using any cracking method may result in product malfunction or data loss and void your warranty.

Newland Europe BV reserves the right to make a final interpretation of the statement above.

Newland Europe BV

Rolweg 25, 4104 AV, Culemborg,
The Netherlands
www.newland-id.com

Newland Europe BV is a subsidiary of Newland Digital Technology Co., Ltd. Our general conditions of Purchase, Sale and Delivery are filed with the Record Office of the Chamber of Commerce of Utrecht, The Netherlands.

K.v.K. H.R. Utrecht / Chamber of
Commerce Utrecht: Reg. nr. 17109876

Revision History

Version	Description	Date
V1.0.0	Initial release.	June 19th, 2022
V1.0.1	Modify Barcode Programming	September 20th, 2023
V1.0.2	Add Ethernet Communication and Data Editing Functions	April 21th, 2025

Note: This document is applicable to firmware version NVH220-V2_V1.01.008.

Table of Contents

Preface	1
Introduction	1
Chapter Description	1
Chapter 1 Getting Started	3
Introduction	3
Features of the NVH220	3
Accessories	4
Unpacking	4
NVH220 Scanner	5
Data Port	7
Connecting the NVH220 to a Host	8
Using USB Cable	8
Using RS-232 Cable	9
Using Ethernet Cable	9
Power On, Power Off, Reboot	10
Maintenance	11
Auto-learning Instructions	11
Chapter 2 NSet	12
Introduction	12
Main Features	12
Chapter 3 System Settings	13
Introduction	13
Barcode Programming	13
Command Programming	13
NSet Programming	13
Programming Barcode/ Programming Command/Function	14
Use of Programming Barcode	15
Illumination	16
Illumination Color	16
Illumination Rotation Interval	17
Aiming	18
Good Read LED	19
Good Read LED Duration	20

Power On Beep	21
Good Read Beep	22
Good Read Beep Volume	23
Good Read Beep Duration	24
Good Read Beep Frequency	25
Good Read Vibration	26
Good Read Vibration Duration	27
Scan Mode	28
One Reading Timeout	30
Delay	31
Reread Delay	31
Reread Delay Time	32
Reread Delay Time	32
Good Read Delay	33
Good Read Delay Time	34
Image Decoding Timeout	35
Sensitivity	36
Smart Stand Mode	37
Read Barcode On/Off	38
Decode Area	38
Set Device Image Sensor Region Of Interest (ROI)	39
Image Flipping	40
Exposure Settings	41
Maximum Exposure Time	42
Minimum Exposure Tim	42
Gain Parameter Limit	43
Set Maximum Gain Parameter	43
Set Minimum Gain Parameter	43
Transmit Not Good Read Message	44
Edit NGR Message	45
Default Settings	46
Factory Defaults	46
Query Scanner Information	47
Query Product Name	47
Query Firmware Version	47
Query Decoder Version	48
Query Hardware Version	48
Query Serial Number	48

Query Manufacturing Date	48
Chapter 4 RS-232 Interface	49
Introduction	49
Baud Rate	50
Parity Check	52
Data Bit	53
Stop Bit	54
Chapter 5 USB Interface	55
Introduction	55
USB HID Keyboard	56
USB Country Keyboard Types	57
Beep on Unknown Character	62
Emulate ALT+Keypad	63
Code Page	64
Unicode Encoding	67
Emulate Keypad with Leading Zero	68
Function Key Mapping	69
ASCII Function Key Mapping Table	70
ASCII Function Key Mapping Table (Continued)	71
Inter-Keystroke Delay	72
Caps Lock	73
Convert Case	74
Emulate Numeric Keypad	75
Polling Rate	79
USB CDC	81
USB HID-POS	82
Introduction	82
Access the Scanner with Your Program	82
Acquire Scanned Data	83
Send Command to the Scanner	83
VID/PID	84
Chapter 6 Ethernet Interface	85
Introduction	85
Device IP configuration	85
Ethernet Output Channel	87
TCP Server	87

TCP Client	87
Chapter 7 Symbologies	89
Introduction	89
Global Settings	89
Enable/Disable All Symbologies	89
Enable/Disable 1D Symbologies	90
Enable/Disable 2D Symbologies	91
1D Inverse	92
Surround GS1 Application Identifiers (AIs) with Parentheses	93
Output GS1 Application Identifiers (AIs)	94
GS1-128(UCC/EAN-128)	95
GS1 Composite	95
GS1 QR	96
GS1 Data Matrix	96
Code 11	97
Restore Factory Defaults	97
Enable/Disable Code 11	97
Set Length Range for Code 11	98
Check Character Verification	99
Transmit Check Character	101
Security Level	102
Code 128	103
Restore Factory Defaults	103
Enable/Disable Code 128	103
Set Length Range for Code 128	104
Security Level	105
Code 39	106
Restore Factory Defaults	106
Enable/Disable Code 39	106
Set Length Range for Code 39	107
Check Character Verification	108
Transmit Start/Stop Character	109
Enable/Disable Code 39 Full ASCII	109
Enable/Disable Code 32 (Italian Pharma Code)	110
Code 32 Prefix	110
Transmit Code 32 Start/Stop Character	111
Transmit Code 32 Check Character	111

Security Level	112
GS1-128 (UCC/EAN-128)	113
Restore Factory Defaults	113
Enable/Disable GS1-128	113
Set Length Range for GS1-128	114
Security Level	115
GS1 Composite (EAN·UCC Composite)	116
Restore Factory Defaults	116
Enable/Disable GS1 Composite	116
Enable/Disable UPC/EAN Composite	117
Output 1D Barcode Only	117
Security Level	118
AIM 128	119
Restore Factory Defaults	119
Enable/Disable AIM 128	119
Set Length Range for AIM 128	120
Security Level	121
ISBT 128	122
Restore Factory Defaults	122
Enable/Disable ISBT 128	122
Security Level	123
Codabar	124
Restore Factory Defaults	124
Enable/Disable Codabar	124
Set Length Range for Codabar	125
Check Character Verification	126
Start/Stop Character	127
Security Level	128
Code 93	129
Restore Factory Defaults	129
Enable/Disable Code 93	129
Set Length Range for Code 93	130
Security Level	131
UPC-A	132
Restore Factory Defaults	132
Enable/Disable UPC-A	132
Transmit Check Character	133
2-Digit Add-On Code	134

5-Digit Add-On Code	135
Add-On Code Required	136
Transmit Preamble Character	137
Security Level	138
UPC-E	139
Restore Factory Defaults	139
Enable/Disable UPC-E	139
Transmit Check Character	140
2-Digit Add-On Code	141
5-Digit Add-On Code	142
Add-On Code Required	143
Transmit Preamble Character	144
UPC-E0	145
UPC-E1	145
Security Level	146
EAN-8	147
Restore Factory Defaults	147
Enable/Disable EAN-8	147
Transmit Check Character	148
2-Digit Add-On Code	149
5-Digit Add-On Code	150
Add-On Code Required	151
Security Level	152
EAN-13	153
Restore Factory Defaults	153
Enable/Disable EAN-13	153
Transmit Check Character	154
2-Digit Add-On Code	155
5-Digit Add-On Code	156
Add-On Code Required	157
Security Level	158
ISSN	159
Restore Factory Defaults	159
Enable/Disable ISSN	159
Security Level	160
Interleaved 2 of 5	161
Restore Factory Defaults	161
Enable/Disable Interleaved 2 of 5	161

Set Length Range for Interleaved 2 of 5	162
Check Character Verification	163
Febraban	164
Security Level	165
Matrix 2 of 5	166
Restore Factory Defaults	166
Enable/Disable Matrix 2 of 5	166
Set Length Range for Matrix 2 of 5	167
Check Character Verification	168
Security Level	169
Industrial 2/5	170
Restore Factory Defaults	170
Enable/Disable Industrial 2/5	170
Set Length Range for Industrial 25	171
Check Character Verification	172
Security Level	173
ITF-14	174
Restore Factory Defaults	174
Enable/Disable ITF-14	175
Security Level	176
ITF-6	177
Restore Factory Defaults	177
Enable/Disable ITF-6	178
Security Level	179
Standard 2/5	180
Restore Factory Defaults	180
Enable/Disable Standard 2/5	180
Set Length Range for Standard 25	181
Check Character Verification	182
Security Level	183
Plessey	184
Restore Factory Defaults	184
Enable/Disable Plessey	184
Set Length Range for Plessey	185
Check Character Verification	186
Security Level	187
PDF417	188
Restore Factory Defaults	188

Enable/Disable PDF417	188
Set Length Range for PDF417	189
PDF417 Inverse	190
PDF417 ECI Output	191
Character Encoding	192
QR Code	193
Restore Factory Defaults	193
Enable/Disable QR Code	193
Set Length Range for QR Code	194
QR Inverse	195
Character Encoding	196
QR ECI Output	197
Website QR Code	197
Custom URL QR	198
Micro QR Code	198
Restore Factory Defaults	198
Enable/Disable Micro QR	199
Set Length Range for Micro QR	200
Data Matrix	201
Restore Factory Defaults	201
Enable/Disable Data Matrix	201
Set Length Range for Data Matrix	202
Rectangular Barcode	203
Data Matrix Inverse	204
Character Encoding	205
Data Matrix ECI Output	205
Aztec	206
Restore Factory Defaults	206
Enable/Disable Aztec Code	206
Set Length Range for Aztec Code	207
Aztec Inverse	208
Character Encoding	209
Aztec ECI Output	209
Chapter 8 Prefix & Suffix	210
Introduction	210
Global Settings	211
Enable/Disable All Prefixes/Suffixes	211

Prefix Sequence	211
Custom Prefix	212
Enable/Disable Custom Prefix	212
Set Custom Prefix	212
AIM ID Prefix	213
Code ID Prefix	214
Restore All Default Code IDs	214
Modify Code ID	215
Custom Suffix	220
Enable/Disable Custom Suffix	220
Set Custom Suffix	220
Terminating Character Suffix	221
Enable/Disable Terminating Character Suffix	221
Set Terminating Character Suffix	222
Chapter 9 Data Formatter	223
Introduction	223
Add a Data Format	223
Programming with Barcodes	223
Programming with Serial Commands	226
Enable/Disable Data Formatter	227
Non-Match Error Beep	229
Data Format Selection	230
Change Data Format for a Single Scan	231
Clear Data Format	232
Query Data Formats	233
Formatter Command	234
Send Commands	234
Move Commands	237
Search Commands	239
Miscellaneous Commands	242
Chapter 10 Lua Scripting	248
Introduction	248
Enable Lua Scripting	248
Disable Lua Scripting	248
Reference Documentation	248
Appendix	249

Digit Barcodes	249
Save/Cancel Barcodes	252
Factory Defaults Table	253
AIM ID Table	261
Code ID Table	262
Symbology ID Number	263
ASCII Table	264

Preface

Introduction

This manual provides detailed instructions for setting up and using the NLS-NVH220 Industrial Handheld Barcode Scanner (hereinafter referred to as “**the NVH220**” or “**the scanner**”).

Chapter Description

<i>Chapter 1 Getting Started</i>	: Gives a general description of NVH220 scanner.
<i>Chapter 2 NSet</i>	: Introduces a useful tool you can use to set up NVH220 scanner and develop new applications.
<i>Chapter 3 System Settings</i>	: Introduces three configuration methods and describes how to configure general parameters of NVH220 scanner.
<i>Chapter 4 RS-232 Interface</i>	: Describes how to configure RS-232 communication parameters.
<i>Chapter 5 USB Interface</i>	: Describes how to configure USB communication parameters.
<i>Chapter 6 Ethernet Communication</i>	: Describes how to configure Ethernet communication parameters.
<i>Chapter 7 Symbologies</i>	: Lists all compatible symbologies and describes how to configure the relevant parameters.
<i>Chapter 8 Prefix & Suffix</i>	: Describes how to use prefix and suffix to customize scanned data.
<i>Chapter 9 Data Formatter</i>	: Explains how to customize scanned data with the data formatter.
<i>Chapter 10 Lua Scripting</i>	: Explains how to use Lua scripting
<i>Appendix</i>	: Provides factory defaults table and a bunch of frequently used programming barcodes.

Explanation of Icons



Tools

This icon indicates something relevant to this manual.



This icon indicates this information requires extra attention from the reader.



This icon indicates handy tips that can help you use or configure the scanner with ease.



This icon indicates practical examples that can help you to acquaint yourself with operations.

Chapter 1 Getting Started

Introduction

The NVH220 reads a 1D or 2D barcode by capturing its image. Adopting the advanced **UIMG**[®] technology independently developed by Newland Auto-ID Tech, it provides several scan modes to different scanning needs.

An illustrated introduction to the NVH220 is included in this chapter. If you have a scanner at hand, make good use of it to develop a better understanding of this manual. This chapter is written for normal users, maintenance staff and software developers.

Features of the NVH220

- Excellent DPM Decoding Capability
- Advanced Illumination system
- Fast Intelligent Learning and Rich Scene Configuration
- High Protection Industrial Structure Design

Model description

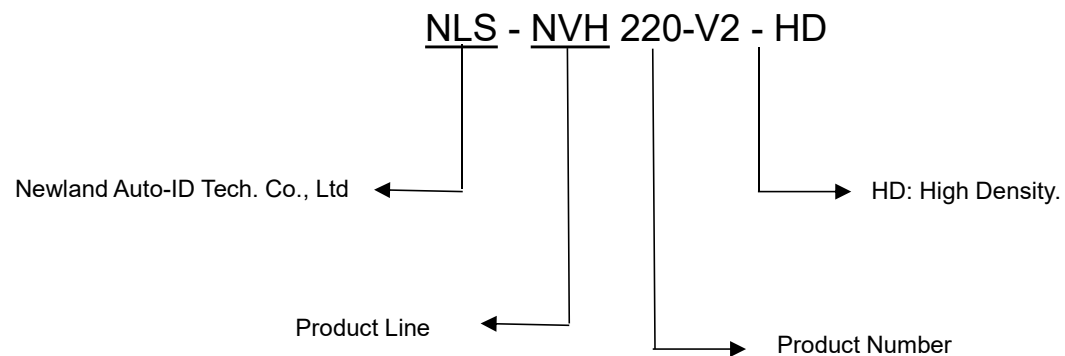

Accessories

Name	Specification	Number
NLS-NVH220-V2 Scanner	NLS-NVH220-V2	1
USB or RS232/Ethernet Cable	RJ45 to USB or RS232/Ethernet	1
Power Adapter (only packed together with RS232/Ethernet Cable)	Output: DC 5V,1.5A	1
Quick Start Manual	Paper	1

Unpacking

Open the package and take out the scanner and its accessories. Check to make sure everything on the packing list is present and intact. If any contents are damaged or missing, please keep the original package and contact your dealer immediately for after-sales service.

NVH220 Scanner

NVH220

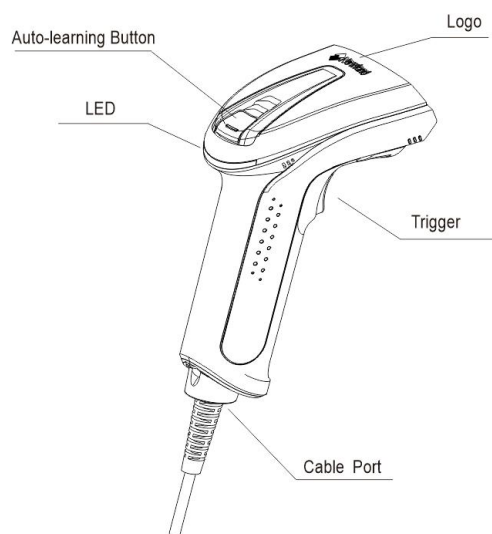

Good Read/Network LED:

Green LED: Barcode decoding successful/
Auto-learning successful

Auto-learning successful

Red LED: Auto-learning failed.

Dimensions of the Scanner (unit: mm)

NVH220

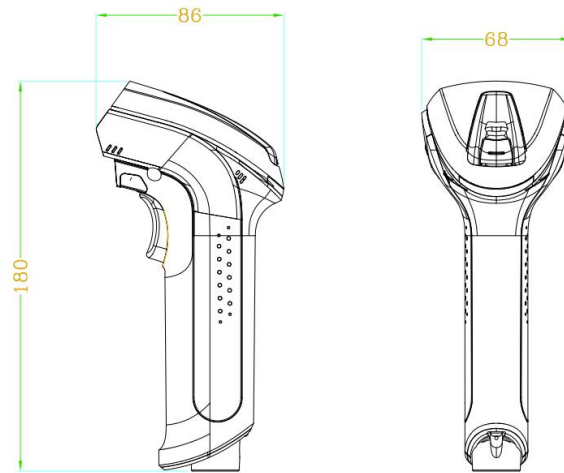

Data Port

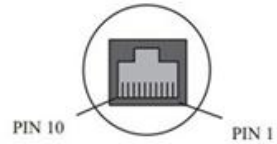
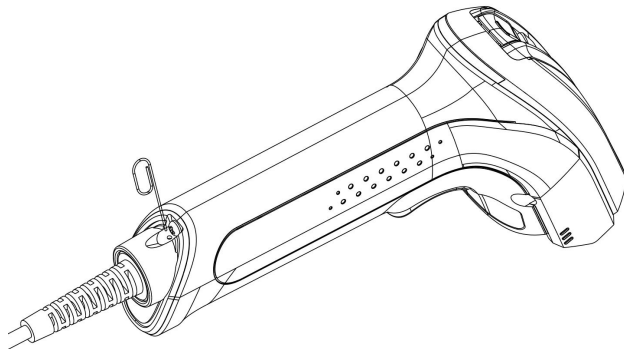

Data Port Pinout:

PIN	Signal	Type	Function
1	RXP	I	Positive terminal for Ethernet data reception
2	RXN	I	Negative terminal for Ethernet data reception
3	VCC	P	Power, +5V
4	TXD	O	RS-232 Output
5	RXD	I	RS-232 Input
6	TXP	O	Positive terminal for Ethernet data transmission
7	TXN	O	Negative terminal for Ethernet data transmission
8	GND	P	Ground
9	D-	I/O	USB Signal
10	D+	I/O	

Connecting the NVH220 to a Host

The scanner must be connected to a host device in actual application, such as PC, POS or any intelligent terminal with USB or RS-232, using a communication cable (USB or RS-232 cable).

USB

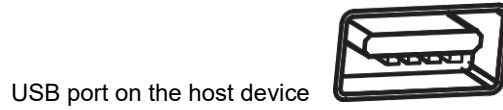

RS-232

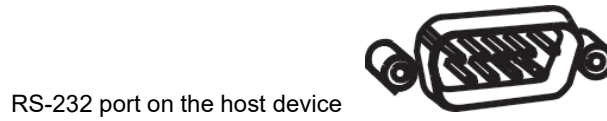

Ethernet

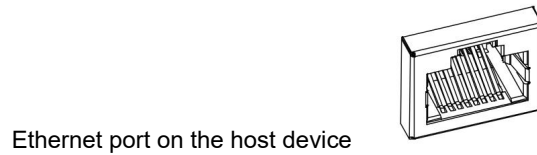

Using USB Cable

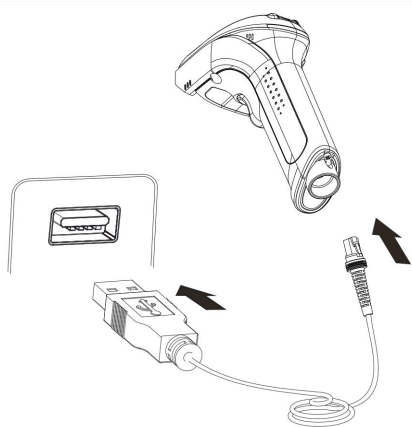

Connect the scanner to a host device through a USB cable with RJ45 and USB connectors:

1. Plug the RJ45 connector into the data port on the scanner.
2. Plug the USB connector into the USB port on the host device.

Using RS-232 Cable

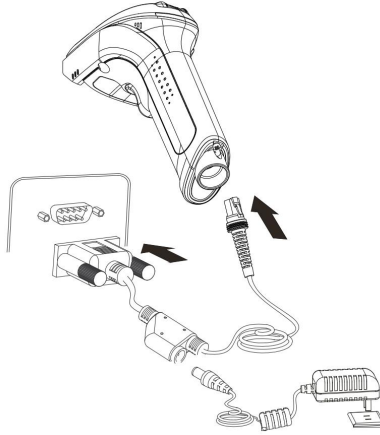

Connect the scanner to a host device through a RS-232 cable with RJ45 and RS-232 connectors and a power jack:

1. Plug the RJ45 connector into the data port on the scanner.
2. Plug the RS-232 connector into the RS-232 port on the host device.
3. Plug the supplied power adapter into the power jack on the RS-232 cable.

Using Ethernet Cable

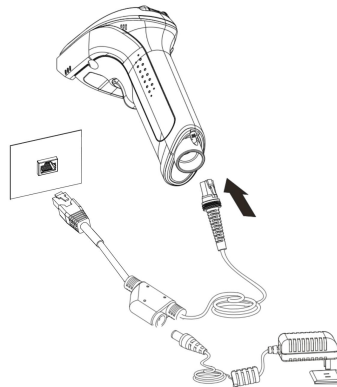

Connect the scanner to a host device through a Ethernet cable with RJ45 connectors and a power jack:

1. Plug the Round-headed RJ45 connector into the data port on the scanner.
2. Plug the flat-headed RJ45 connector into the LAN port on the host device.
3. Plug the supplied power adapter into the power jack on the Ethernet cable.

Power On, Power Off, Reboot

Power on the scanner

Connect the scanner to a host device. Then the scanner will be turned on and automatically enter the sleep mode.

Power off the scanner

Remove the cable from the scanner; or remove the cable from the host device; or disconnect the power adapter from mains.

Reboot the scanner

If the scanner stops responding to input or runs abnormally, turn off the scanner and then turn it back on.

Maintenance

- ◇ The scan window should be kept clean.
- ◇ Do not scratch the scan window.
- ◇ Use soft brush to remove the stain from the scan window.
- ◇ Use the soft cloth to clean the window, such as eyeglass cleaning cloth.
- ◇ Do not spray any liquid on the scan window.
- ◇ Do not use any detergent to clean other parts of the scanner except for water.



The warranty **DOES NOT** cover damages caused by inappropriate care and maintenance.

Auto-learning Instructions

1. Ensure the scanner is correctly connected to the host device and power supply before powering it on.
2. Press and hold the trigger button at the top of the scanner for three seconds to enter auto-learning mode. The illumination light will activate, and the red cross-hair laser focus will appear. Maintain the scanning position. If the scanner continuously emits successful decode beeps and the LED indicator turns green, self-learning is successful. If the LED indicator turns red, self-learning has failed.

Note: The results of a successful auto-learning will be saved to the current Configuration Library. If “Save to Device” is selected, the illumination color configuration can be used during actual scanning.

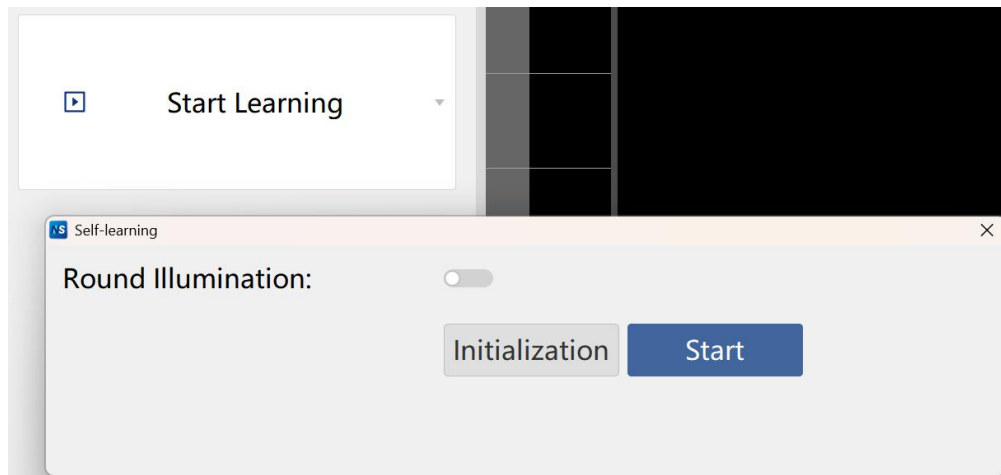

Chapter 2 NSet

Introduction

NSet Setup Tool is a User Interface client application developed by Fujian Newland Auto-ID Tech. Co., Ltd. That simplifies initial reader setup and changing parameters of the scanners you use.

The NSet is a common platform across all models. It is installed in and runs on Windows-based PCs (usually laptops), and connection takes place through several different interface.

Main Features

- Debug equipment parameters and take effect in real time, view scanned images and barcode reading data in real time ;
- Upgrade the firmware, import the configurations, restore to the factory default ,etc in batch;
- Provide configuration comparison between multiple devices to analyze the performance differences of different devices;
- Generate the setting barcodes for the configuration of the scanner, and save them as a PDF or Word file;
- Interact with the device through commands;
- Provide quick selection tools to help users quickly assess scene requirements, precisely select the model and determine the installation location

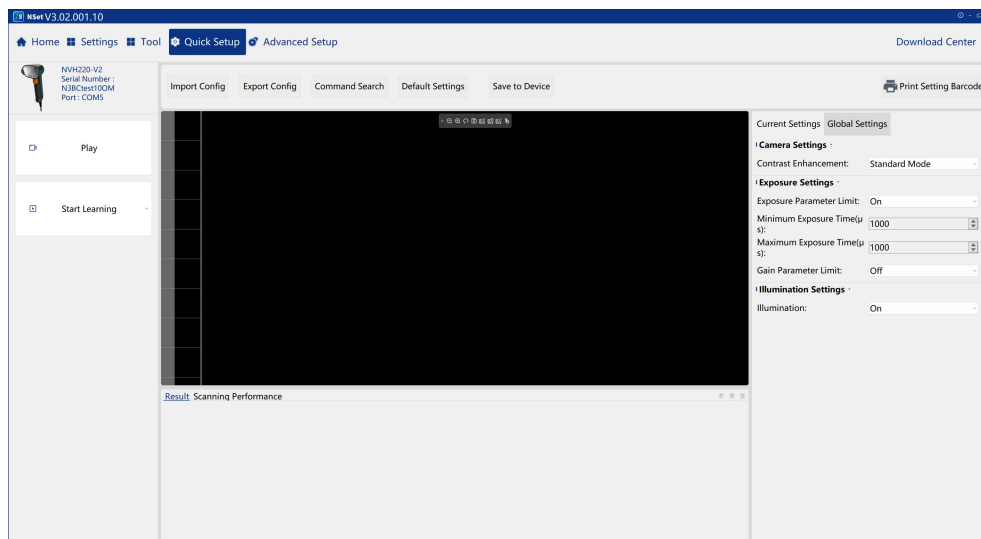

Chapter 3 System Settings

Introduction

There are three ways to configure the NVH220: Barcode programming, command programming and NSet programming.

Barcode Programming

The NVH220 can be configured by scanning programming barcodes. All user programmable features/options are described along with their programming barcodes/commands in the following sections.

This programming method is most straightforward. However, it requires manually scanning barcodes. As a result, errors are more likely to occur.

Command Programming

The NVH220 can also be configured by serial commands (HEX) sent from the host device.

Users can design an application program to send those command strings to the scanners to perform device configuration.

NSet Programming

Besides the two methods mentioned above, you can conveniently perform scanner configuration through NSet too. NSet is a Windows-based configuration tool particularly designed for Newland products, enabling users to gain access to decoded data and captured images and to configure scanners. For more information about this tool, refer to the *NSet User Guide*.

Programming Barcode/ Programming Command/Function



The figure above is an example that shows you the programming barcode and command for the Level Mode function:

1. The **Level Mode** barcode.
2. The **Level Mode** command.
3. The description of feature/option.
4. ** indicates factory default settings.

Note: "@" included in the programming command indicates permanent setting which means the setting will not be lost by removing power from the scanner or turning off or rebooting it; whereas "#" included in the programming command indicates temporary setting which means the setting will be lost by removing power from the scanner or turning off or rebooting it.

Use of Programming Barcode

Programming barcode data (i.e. the characters under programming barcode) can be transmitted to the host device. Scan the appropriate barcode below to enable or disable the transmission of programming barcode data to the host device.



@SETUPT0

**** Do Not Transmit Programming Barcode Data**



@SETUPT1

Transmit Programming Barcode Data

Illumination



@ILLSCN1

** On



@ILLSCN0

Off

Illumination Color



@ILLCLR0

Red LED



@ILLCLR1

White LED



@ILLCLR2

Red and White LED



@ILLCLR4

Blue LED



@ILLCLR5

Red , White, and Blue LED



@ILLCLR6

Blue and White LED



@ILLCLR7

Blue and Red LED

Illumination Rotation Interval

This parameter sets the Illumination Rotation Interval (10-30000ms). The default value is 5000ms.



@ILLSCT

Illumination Rotation Interval

Aiming

When scanning/capturing image, the scanner projects an aiming pattern which allows positioning the target barcode within its field of view and thus makes decoding easier.

Normal: The scanner projects an aiming pattern only during barcode scanning/capture.

Always On: Aiming pattern is constantly on after the scanner is powered on.

Off: Aiming pattern is off all the time.



@AMLENA1

**** Normal**



@AMLENA0

Off



@AMLENA2

Always On

Good Read LED

The green LED can be programmed to be On or Off to indicate good read.



@GRLENA1

**** On**



@GRLENA0

Off

Good Read LED Duration

This parameter sets the amount of time the Good Read LED remains on following a good read. It is programmable from 1ms to 10,000ms.



@GRLDUR20

**** Short (20ms)**



@GRLDUR120

Medium (120ms)



@GRLDUR220

Long (220ms)



@GRLDUR320

Prolonged (320ms)



@GRLDUR

Custom (1 - 10,000ms)

E
xample

Set the Good Read LED duration to 800ms:

1. Scan the **Custom** barcode.
2. Scan the numeric barcodes “8”, “0” and “0” from the “Digit Barcodes” section in Appendix.
3. Scan the **Save** barcode from the “Save/Cancel Barcodes” section in Appendix.

Power On Beep

The scanner can be programmed to beep when it is powered on. Scan the **Off** barcode if you do not want a power on beep.



@PWBENA1

** On



@PWBENA0

Off

Good Read Beep

Scanning the **Off** barcode can turn off the beep that indicates successful decode; scanning the **On** barcode can turn it back on.



@GRBENA1

**** On**



@GRBENA0

Off

Good Read Beep Volume

Scanning the below barcode can set the Good Read Beep Volume to low, medium and high.



@GRBVLL5

Low Volume



@GRBVLL12

Medium Volume



@GRBVLL20

****High Volume**

Good Read Beep Duration

This parameter sets the length of the beep the scanner emits on a good read.



@GRBDUR40

Short (40ms)



@GRBDUR80

**** Medium (80ms)**



@GRBDUR120

Long (120ms)

Good Read Beep Frequency

This parameter is programmable in 1Hz increments from 20Hz to 20,000Hz.



@GRBFRQ2730

**** Medium (2730Hz)**



@GRBFRQ1600

Low (1600Hz)



@GRBFRQ4200

High (4200Hz)

E
sample

Set the Good Read Beep frequency to 2,000Hz:

1. Scan the **Custom** barcode.
2. Scan the numeric barcodes “2”, “0”, “0” and “0” from the “Digit Barcodes” section in Appendix.
3. Scan the **Save** barcode from the “Save/Cancel Barcodes” section in Appendix.

Good Read Vibration

You may choose whether or not to let the scanner vibrate when a barcode is successfully read by scanning the appropriate barcode below.



@GRVENA0

**** Off**



@GRVENA1

On

Good Read Vibration Duration

This parameter sets the length for the Good Read Vibration. It is programmable in 1ms increments from 1ms to 2,000ms. The default value is 100ms.



@GRVDUR

Set Good Read Vibration Duration

E
xample

Set the Good Read Vibration duration to 800ms:

1. Scan the Set Good Read Vibration Duration barcode.
2. Scan the numeric barcodes “8”, “0” and “0” from the “Digit Barcodes” section in Appendix.
3. Scan the Save barcode from the “Save/Cancel Barcodes” section in Appendix.

Scan Mode

Level Mode: A trigger pull activates a decode session. The decode session continues until a barcode is decoded or the trigger is released.

Sense Mode: The scanner activates a decode session every time when it detects a change in ambient illumination. The decode session continues until the barcode is decoded or the decode session timeout expires. Pressing the trigger can also activate a decode session.

Continuous Mode: The scanner automatically starts one decode session after another. To suspend/resume barcode reading, simply press the trigger. **Reread Timeout** can avoid undesired rereading of same barcode in a given period of time.

Pulse Mode: When the trigger is pulled and released, scanning is activated until a barcode is decoded or the decode session timeout expires (The decode session timeout begins when the trigger is released).

Batch Mode: A trigger pull activates a round of multiple decode sessions. This round of multiple scans continues until the trigger is released. Rereading the same barcode is not allowed in the same round.



@SCNMOD0

Level Mode



@SCNMOD2

Sense Mode



@SCNMOD3

Continuous Mode



@SCNMOD7

Batch Mode



@SCNMOD4

Pulse Mode

One Reading Timeout

This parameter sets the maximum time decode session continues during a scan attempt. It is programmable in 1ms increments from 0ms to 3,600,000ms. When it is set to 0, the timeout is infinite. The default setting is 3,000ms.



@ORTSET

One Reading Timeout

E
sample

Set the One Reading Timeout to 1,500ms:

1. Scan the **One Reading Timeout** barcode.
2. Scan the numeric barcodes “1”, “5”, “0” and “0” from the “Digit Barcodes” section in Appendix.
3. Scan the Save barcode from the “Save/Cancel Barcodes” section in Appendix.

Delay

Reread Delay

Reread delay can avoid undesired rereading of same barcode in a given period of time. This feature is only applicable to the Sense and Continuous modes.

Enable Reread Delay: Do not allow the scanner to re-read same barcode before the timeout between decodes (same barcode) expires.

Disable Reread Delay: Allow the scanner to re-read same barcode



@RRDENA1

****On**



@RRDENA0

Off

Reread Delay Time

The following parameter sets the timeout between decodes for same barcode. It is programmable in 1ms increments from 0ms to 3,600,000ms. The default setting is 15,000ms.



@RRDDUR

Reread Delay Time

E
example

Set the Reread Delay Time to 1,000ms:

1. Scan the **Reread Delay Time** barcode.
2. Scan the numeric barcodes “1”, “0”, “0” and “0” from the “Digit Barcodes” section in Appendix.
3. Scan the Save barcode from the “Save/Cancel Barcodes” section in Appendix.

Good Read Delay

Good Read Delay sets the minimum amount of time before the scanner can read another barcode. This parameter is programmable in 1ms increments from 1ms to 3,600,000ms. The default setting is 500ms. Scan the appropriate barcode below to enable or disable the delay.



@GRDNA1

Enable Good Read Delay



@GRDNA0

**** Disable Good Read Delay**

Good Read Delay Time

To set the good read delay, scan the barcode below, then set the delay (from 1 to 3,600,000ms) by scanning the digit barcode(s) then scanning the **Save** barcode from the Appendix. The default value is 500ms.



@GRDDUR

Good Read Delay Time

E
sample

Set the Good Read Delay Time to 1,000ms:

1. Scan the Good Read Delay Time barcode.
2. Scan the numeric barcodes “1”, “0”, “0” and “0” from the “Digit Barcodes” section in Appendix.
3. Scan the Save barcode from the “Save/Cancel Barcodes” section in Appendix.

Image Decoding Timeout

Image Decoding Timeout specifies the maximum time the scanner will spend decoding an image. This parameter is programmable in 1ms increments from 1ms to 3,000ms. The default timeout is 500ms.



@DETSET

Image Decoding Timeout

E
example

Set the image decoding timeout to 800ms:

1. Scan the **Image Decoding Timeout** barcode.
2. Scan the numeric barcodes “8”, “0” and “0” from the “Digit Barcodes” section in Appendix.
3. Scan the **Save** barcode from the “Save/Cancel Barcodes” section in Appendix.

Sensitivity

Sensitivity specifies the degree of acuteness of the scanner's response to changes in images captured. There are 20 levels to choose from. The smaller the value, the higher the sensitivity and the lower requirement in image change to trigger the scanner. You can select an appropriate degree of sensitivity that fits the application environment. The default setting is Level 5. This feature is only applicable to the Sense mode.



@SENLVL14

Low Sensitivity



@SENLVL11

Medium Sensitivity



@SENLVL8

High Sensitivity



@SENLVL5

****Enhance Sensitivity**



@SENLVL

****Custom Sensitivity**

E
xample

Set the Sensitivity to 10:

1. Scan the **Custom Sensitivity** barcode.
2. Scan the numeric barcodes "1", "0" from the "Digit Barcodes" section in Appendix.
3. Scan the **Save** barcode from the "Save/Cancel Barcodes" section in Appendix.

Smart Stand Mode

After this feature is turned on, the scanner will switch from its current scan mode to the Sense mode when it is inserted in the stand, and it will operate in its previous scan mode when it is removed from the stand.



@SMTENA0

**** Disable Smart Stand Mode**



@SMTENA1

Enable Smart Stand Mode

Read Barcode On/Off

Sending the Read Barcode Off command ~<SOH>0000#SCNENA0;<ETX> to the scanner can disable it from reading barcode, and the scanner is unable to scan barcode unless you send the Read Barcode On command ~<SOH>0000#SCNENA1;<ETX> to it or power cycle it. By default, Read Barcode is On.

Decode Area

Whole Area Decoding: The scanner attempts to decode barcode(s) within its field of view, from the center to the periphery, and transmits the barcode that has been first decoded.

Acuscan: The scanner only decodes the barcode aimed squarely by the aiming pattern. For those using a crosshair aiming pattern, only the barcode aimed by the center of crosshair will be decoded.

Priori On Aimed Barcode: The scanner attempts to decode priority the aimed barcode(s). If there is no barcode in the aimed area, the scanner would decode the barcode which is close to the aiming area first.



@CADENA0

Whole Area Decoding



@CADENA2

Acuscan



@CADENA4;

****Priori On Aimed Barcode**

Set Device Image Sensor Region Of Interest (ROI)

When decoding images, the scanner can be configured to focus on a specific area of the image sensor using Nset. The image resolution can be customized, which can improve decoding speed.

Image Flipping



@MIRROR0

**** Do Not Flip**



@MIRROR1

Flip Horizontally



@MIRROR2

Flip Vertically



@MIRROR3

Flip Horizontally & Vertically

Example of image not flipped



Example of image flipped horizontally



Example of image flipped vertically



Example of image flipped horizontally & vertically



Exposure Settings

This function determines whether the exposure parameter used by the scanner to take a picture is limited by the maximum exposure time and the minimum exposure time

- ✧ Off: The exposure time range of the photograph is controlled by the scanner firmware,
- ✧ On: The exposure time range of the photograph is between the maximum and minimum exposure time.



@EXPEEN0

** Off



@EXPEEN1

On

Maximum Exposure Time



@EXPEMX

Maximum Exposure Time

Minimum Exposure Tim



@EXPEMN

Minimum Exposure Time

Gain Parameter Limit

This function determines whether the gain parameters used by the scanner to take the picture are limited by the maximum and minimum gain.

- ✧ Off: Gain parameter is controlled by the scanner firmware.
- ✧ On: Gain parameter range of the photograph is between the maximum and minimum exposure time.



@EXPGEN0

** Off



@EXPGEN1

On

Set Maximum Gain Parameter



@EXPGMX

Maximum Gain Parameter

Set Minimum Gain Parameter



@EXPGMN

Maximum Gain Parameter

Transmit Not Good Read Message

- ✧ Enable: When the code failed to decoded, and you release the trigger or Decode Session Timeout , Not Good Read Message will be sent to the host.
- ✧ Disable: When the code failed to decoded, Not Good Read Message will not be sent to the host.



@NGRENA0

** Disable



@NGRENA1

Enable

Edit NGR Message

Not Good Read Message supports up to 7 characters, from 0 to oxff. (Default: NG)



@NGRSET

Edit NGR Message

Default Settings

Factory Defaults

Scanning the following barcode can restore the scanner to the factory defaults.

You may need to reset all parameters to the factory defaults when:

- ✧ Scanner is not properly configured so that it fails to decode barcodes.
- ✧ You forget previous configuration and want to avoid its impact.

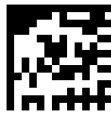

@FACDEF

Restore All Factory Defaults

Query Scanner Information

After scanning the barcode below, the scanner information (including product name, firmware version, decoder version, hardware version, product serial number, OEM serial number and manufacturing date) will be sent to the host device.



@QRYSYS

Query Scanner Information

Query Product Name



@QRYPDN

Query Product Name

Query Firmware Version



@QRYFWV

Query Firmware Version

Query Decoder Version



@QRYDCV

Query Decoder Version

Query Hardware Version



@QRYHWV

Query Hardware Version

Query Serial Number



@QRYPSN

Query Serial Number

Query Manufacturing Date



@QRYDAT

Query Manufacturing Date

Chapter 4 RS-232 Interface

Introduction

When the cradle is connected to the RS-232 port of a host device, you need to set communication parameters (including baud rate, parity check, data bit and stop bit) on the cradle to match the host device so that two devices can communicate with each other.



@INTERF0

RS-232

Baud Rate

Baud rate is the number of bits of data transmitted per second. Set the baud rate to match the host requirements.



@232BAD8

115200



@232BAD7

57600



@232BAD6

38400



@232BAD4

14400



@232BAD5

19200



@232BAD3

**** 9600**



@232BAD2

4800



@232BAD1

2400



@232BAD0

1200

Parity Check

Set the parity type to match the host requirements.

Odd Parity: If the data contains an odd number of 1 bits, the parity bit value is set to 0.

Even Parity: If the data contains an even number of 1 bits, the parity bit value is set to 0.

None: Select this option when no parity bit is required.



@232PAR0

**** None**



@232PAR2

Odd Parity



@232PAR1

Even Parity

Data Bit

Set the number of data bits to match the host requirements.



@232DAT1

7 Data Bits



@232DAT0

**** 8 Data Bits**

Stop Bit

The stop bit(s) at the end of each transmitted character marks the end of transmission of one character and prepares the receiving device for the next character in the serial data stream. Set the number of stop bits to match the host requirements.



@232STP0

**** 1 Stop Bit**



@232STP1

2 Stop Bits

Chapter 5 USB Interface

Introduction

There are three options for USB connection.

1. **USB Keyboard:** The scanner's transmission is simulated as USB keyboard input with no need for command configuration or a driver. Barcode data could be entered by the virtual keyboard directly and it is also convenient for the host device to receive data.
2. **USB CDC:** The USB CDC feature allows the host device to receive data in the way as a serial port does. A driver is needed when using this feature.
3. **HID-POS:** It is based on the HID interface, with no need for a custom driver. It excels virtual keyboard and traditional RS-232 interface in transmission speed.

When the scanner is connected to both USB and RS-232 ports on a host device, it will select the USB connection by default.

USB HID Keyboard

When the cradle is connected to the USB port on a host device, you can enable the USB HID Keyboard feature by scanning the barcode below. The cradle's transmission will be simulated as USB keyboard input. The Host receives keystrokes on the virtual keyboard. It works on a Plug and Play basis and no driver is required.



@INTERF3

**** USB HID Keyboard**



If the host device allows keyboard input, then no extra software is needed for HID Keyboard input.

USB Country Keyboard Types

Keyboard layouts vary from country to country. The default setting is U.S. keyboard.



@KBWCTY0

**** U.S. (English)**



@KBWCTY1

Belgium



@KBWCTY2

Brazil



@KBWCTY3

Canada (French)



@KBWCTY4

Czechoslovakia



@KBWCTY5

Denmark



@KBWCTY6

Finland (Swedish)



@KBWCTY7

France



@KBWCTY8

Germany/ Austria



@KBWCTY9

Greece



@KBWCTY10

Hungary



@KBWCTY11

Israel (Hebrew)



@KBWCTY12

Italy



@KBWCTY13

Latin America/ South America



@KBWCTY14

Netherlands (Dutch)



@KBWCTY15

Norway



@KBWCTY16

Poland



@KBWCTY17

Portugal



@KBWCTY18

Romania



@KBWCTY19

Russia



@KBWCTY21

Slovakia



@KBWCTY22

Spain



@KBWCTY23

Sweden



@KBWCTY24

Switzerland (German)



@KBWCTY25

Turkey_F



@KBWCTY26

Turkey_Q



@KBWCTY27

UK



@KBWCTY36

Slovenia



@KBWCTY28

Japan

Beep on Unknown Character

Due to the differences in keyboard layouts, some characters contained in barcode data may be unavailable on the selected keyboard. As a result, the scanner fails to transmit the unknown characters.

Scan the appropriate barcode below to enable or disable the emission of beep when an unknown character is detected.



@KBWBUC0

** Do Not Beep on Unknown Character



@KBWBUC1

Beep on Unknown Character

E
sample

Supposing French keyboard (Country Code: 7) is selected and barcode data “AÐF” is being dealt with, the keyboard will fail to locate the “Ð” (0xD0) character and the scanner will ignore the character and continue to process the next one.

Do Not Beep on Unknown Character: The scanner does not beep and the Host receives “AF”.

Beep on Unknown Character: The scanner beeps and the Host still receives “AF”.



If **Emulate ALT+Keypad ON** is selected, **Beep on Unknown Character** does not function.

Emulate ALT+Keypad

When **Emulate ALT+Keypad** is turned on, any ASCII character (0x00 - 0xFF) is sent over the numeric keypad no matter which keyboard type is selected.

1. ALT Make
2. Enter the number corresponding to a desired character on the keypad.
3. ALT Break

After **Emulate ALT+Keypad ON** is selected, you need to choose the code page with which the barcodes were created and to turn **Unicode Encoding** On or Off depending on the encoding used by the application software.



@KBWALTO

**** Emulate ALT+Keypad OFF**



@KBWALT1

Emulate ALT+Keypad ON



Since sending a character involves multiple keystroke emulations, this method appears less efficient.



Supposing **Emulate ALT+Keypad** is ON, **Unicode Encoding** is Off, and **Code Page 1252 (West European Latin)** is selected, barcode data "ADF" (65/208/70) is sent as below:

"A" -- "ALT Make" + "065" + "ALT Break"

"D" -- "ALT Make" + "208" + "ALT Break"

"F" -- "ALT Make" + "070" + "ALT Break"

Code Page

Code pages define the mapping of character codes to characters. If the data received does not display with the proper characters, it may be because the barcode being scanned was created using a code page that is different from the one the host program is expecting. If this is the case, select the code page with which the barcodes were created by scanning the appropriate barcode below. For PDF417, QR Code, Aztec and Data Matrix, besides setting the code page, you also need to set the character encoding in the “Character Encoding” section in Chapter 7. This feature is only effective when **Emulate ALT+Keypad** is turned on.



@KBWCPG0

**** Code Page 1252 (West European Latin)**



@KBWCPG1

Code Page 1251 (Cyrillic)



@KBWCPG2

Code Page 1250 (Central and East European Latin)



@KBWCPG3

Code Page 1253 (Greek)



@KBWCPG4

Code Page 1254 (Turkish)



@KBWCPG5

Code Page 1255 (Hebrew)



@KBWCPG6

Code Page 1256 (Arabic)



@KBWCPG7

Code Page 1257 (Baltic)



@KBWCPG8

Code Page 1258 (Vietnamese)



@KBWCPG9

Code Page 936 (Simplified Chinese, GB2312,GBK)



@KBWCPG10

Code Page 950 (Traditional Chinese, Big5)



@KBWCPG11

Code Page 874(Thai)



@KBWCPG12

Code Page 932 (Japanese, Shift-JIS)

Unicode Encoding

Different host program may use different character encodings for handling incoming barcode data. For instance, Microsoft Office Word uses Unicode encoding and therefore you should turn **Unicode Encoding** on, whereas Microsoft Office Excel or Notepad uses Code Page encoding and therefore you should turn **Unicode Encoding** off. This feature is only effective when **Emulate ALT+Keypad** is turned on.



@KBWCPU0

**** Off**



@KBWCPU1

On

Emulate Keypad with Leading Zero

You may turn this feature on to send character sequences sent over the numeric keypad as ISO characters which have a leading zero. For example, ASCII A transmits as “ALT MAKE” 0065 “ALT BREAK”. This feature is only effective when **Emulate ALT+Keypad** is enabled.



@KBWALZ0

Disable



@KBWALZ1

**** Enable**

Function Key Mapping

When **Ctrl+ASCII Mode** is selected, function characters (0x00 - 0x1F) are sent as ASCII sequences.

1. CTRL Make
2. Press function key
3. CTRL Break



@KBWFKM0

**** Disable**



@KBWFKM1

Ctrl+ASCII Mode



@KBWFKM2;

Alt+Keypad Mode

E
xample

If **Ctrl+ASCII Mode** is selected and other parameters of USB HID Keyboard adopt factory defaults, barcode data "A<HT>(i.e. Horizontal Tab)F" (0x41/0x09/0x46) is sent as below:

"A" - Keystroke "A".

<HT> - "Ctrl Make" + Keystroke "I" + "Ctrl Break"

"F" - Keystroke "F"

For some text editors, "Ctrl I" means italic convert. So the output may be "AF".



Emulate ALT+Keypad ON prevails over **Ctrl+ASCII Mode**.

ASCII Function Key Mapping Table

ASCII Function	ASCII Value (HEX)	Function Key Mapping Disabled	Ctrl+ASCII
NUL	00	Null	Ctrl+@
SOH	01	Keypad Enter	Ctrl+A
STX	02	Caps Lock	Ctrl+B
ETX	03	ALT	Ctrl+C
EOT	04	Null	Ctrl+D
ENQ	05	CTRL	Ctrl+E
ACK	06	Null	Ctrl+F
BEL	07	Enter	Ctrl+G
BS	08	Left Arrow	Ctrl+H
HT	09	Horizontal Tab	Ctrl+I
LF	0A	Down Arrow	Ctrl+J
VT	0B	Vertical Tab	Ctrl+K
FF	0C	Delete	Ctrl+L
CR	0D	Enter	Ctrl+M
SO	0E	Insert	Ctrl+N
SI	0F	Esc	Ctrl+O
DLE	10	F11	Ctrl+P
DC1	11	Home	Ctrl+Q
DC2	12	PrintScreen	Ctrl+R
DC3	13	Backspace	Ctrl+S
DC4	14	tab+shift	Ctrl+T
NAK	15	F12	Ctrl+U
SYN	16	F1	Ctrl+V
ETB	17	F2	Ctrl+W
CAN	18	F3	Ctrl+X
EM	19	F4	Ctrl+Y
SUB	1A	F5	Ctrl+Z
ESC	1B	F6	Ctrl+[
FS	1C	F7	Ctrl+\
GS	1D	F8	Ctrl+]
RS	1E	F9	Ctrl+6
US	1F	F10	Ctrl+-

ASCII Function Key Mapping Table (Continued)

The last five characters (0x1B~0x1F) in the table above apply to US keyboard layout only. The following chart provides the equivalents of these five characters for other countries.

Country	Ctrl+ASCII					
United States	Ctrl+[Ctrl+\	Ctrl+]	Ctrl+6	Ctrl+-	
Belgium	Ctrl+[Ctrl+<	Ctrl+]	Ctrl+6	Ctrl+-	
Scandinavia	Ctrl+8	Ctrl+<	Ctrl+9	Ctrl+6	Ctrl+-	
France	Ctrl+^	Ctrl+8	Ctrl+\$	Ctrl+6	Ctrl+=	
Germany		Ctrl+Ã	Ctrl++	Ctrl+6	Ctrl+-	
Italy		Ctrl+\	Ctrl++	Ctrl+6	Ctrl+-	
Switzerland		Ctrl+<	Ctrl+..	Ctrl+6	Ctrl+-	
United Kingdom	Ctrl+[Ctrl+∅	Ctrl+]	Ctrl+6	Ctrl+-	
Denmark	Ctrl+8	Ctrl+\	Ctrl+9	Ctrl+6	Ctrl+-	
Norway	Ctrl+8	Ctrl+\	Ctrl+9	Ctrl+6	Ctrl+-	
Spain	Ctrl+[Ctrl+\	Ctrl+]	Ctrl+6	Ctrl+-	

Inter-Keystroke Delay

This parameter specifies the delay between emulated keystrokes.



@KBWDLY0

**** No Delay**



@KBWDLY40

Long Delay (40ms)



@KBWDLY20

Short Delay (20ms)

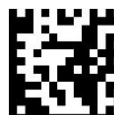

@KBWDLY

Custom Delay (Rang: 0-100)

Caps Lock

The **Caps Lock ON** option can invert upper and lower case characters contained in barcode data. This inversion occurs regardless of the state of Caps Lock key on the host device's keyboard.



@KBWCAP0

**** Caps Lock OFF(Non-Japanese Keyboard)**



@KBWCAP1

Caps Lock ON(Non-Japanese Keyboard)



@KBWCAP2

Caps Lock OFF(Japanese Keyboard)



@KBWCAP3

Caps Lock ON(Japanese Keyboard)



Emulate ALT+Keypad ON/ Convert All to Upper Case/ Convert All to Lower Case prevails over **Caps Lock ON**.



When the **Caps Lock ON** feature is selected, barcode data "AbC" is transmitted as "aBc".

Convert Case

You may scan the appropriate barcode below to convert all barcode data to your desired case.



@KBWCAS0

**** No Case Conversion**



@KBWCAS1

Convert All to Upper Case



@KBWCAS2

Convert All to Lower Case

E
sample

When the **Convert All to Lower Case** feature is enabled, barcode data "AbC" is transmitted as "abc".



If **Emulate ALT+Keypad ON** is selected, **Convert All to Lower Case** and **Convert All to Upper Case** do not function.

Emulate Numeric Keypad



Do Not Emulate Numeric Keypad 1: Sending a number (0-9) is emulated as keystroke(s) on main keyboard.

Emulate Numeric Keypad 1: Sending a number (0-9) is emulated as keystroke(s) on numeric keypad. The state of Num Lock on the simulated numeric keypad is determined by its equivalent on the host device. If Num Lock on the host device is turned off, the output of simulated numeric keypad is function key instead of number.

Do Not Emulate Numeric Keypad 2: Sending "+", "-", "*", and "/" is emulated as keystroke(s) on main keyboard.

Emulate Numeric Keypad 2: Sending "+", "-", "*", and "/" is emulated as keystroke(s) on numeric keypad.



@KBWNUM0

**** Do Not Emulate Numeric Keypad 1**



@KBWNUM1

Emulate Numeric Keypad 1



Emulate ALT+Keypad ON prevails over **Emulate Numeric Keypad**.

E *example*

Supposing the **Emulate Numeric Keypad** feature is enabled:

if Num Lock on the host device is ON, "A4.5" is transmitted as "A4.5";

if Num Lock on the host device is OFF, "A4.5" is transmitted as ".A":

1. "A" is sent on main keyboard;
2. "4" is sent as the function key "Cursor Move to Left";
3. "." is sent on main keyboard;
4. "5" is not sent as it does not correspond to any function key.

Character”+”, ”-“, ”*”, ”/” Adopt Numeric Keypad



@KBWNCH0
**** Of**

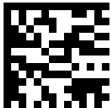

@KBWNCH1
On

Fast Mode

When **Fast Mode On** is selected, the scanner sends characters to the host faster. If the host drops characters, turn the Fast Mode off or change the polling rate to a bigger value.



@KBWFAS0

**** Fast Mode Off**



@KBWFAS1

Fast Mode On

Polling Rate

This parameter specifies the polling rate for a USB keyboard. If the Host drops characters, change the polling rate to a bigger value.



@KBWPOR0

1ms



@KBWPOR1

2ms



@KBWPOR2

3ms



@KBWPOR3

**** 4ms**



@KBWPOR4

5ms



@KBWPOR5

6ms



@KBWPOR6

7ms



@KBWPOR7

8ms



@KBWPOR8

9ms



@KBWPOR9

10ms

USB CDC

If your cradle is connected to the USB port on a host device, the USB CDC feature allows the host device to receive data in the way as a serial port does. A driver is needed when using this feature. You may download it from our website at www.newlandaidc.com.



@INTERF8

USB CDC

USB HID-POS

Introduction

The HID-POS interface is recommended for new application programs. It can send up to 56 characters in a single USB report and appears more efficient than keyboard emulation.

Features:

- ✧ HID based, no custom driver required.
- ✧ Way more efficient in communication than keyboard emulation and traditional RS-232 interface.

Note: HID-POS does not require a custom driver. However, a HID interface on Windows 98 does. All HID interfaces employ standard driver provided by the operating system. Use defaults when installing the driver.



@INTERF8

USB HID-POS

Access the Scanner with Your Program

Use CreateFile to access the scanner as a HID device and then use ReadFile to deliver the scanned data to the application program. Use WriteFile to send data to the scanner.

For detailed information about USB and HID interfaces, go to www.USB.org.

Acquire Scanned Data

After a barcode is decoded, the scanner sends an input report as below:

Byte	Bit							
	7	6	5	4	3	2	1	0
0	Report ID = 0x02							
1	Barcode Length							
2-57	Decoded Data (1-56)							
58-61	Reserved (1-4)							
62	Newland Symbology Identifier or N/C: 0x00							
63	-	-	-	-	-	-	-	Decoded data continued

Send Command to the Scanner

This output report is used to send commands to the scanner. All programming commands can be used.

Byte	Bit							
	7	6	5	4	3	2	1	0
0	Report ID = 0x04							
1	Length of command							
2-62	Command							
63	-	-	-	-	-	-	-	Command continued

VID/PID

USB uses VID (Vendor ID) and PID (Product ID) to identify and locate a device. The VID is assigned by USB Implementers Forum. Newland's vendor ID is 1EAB (Hex). A range of PIDs are used for each Newland product family. Every PID contains a base number and interface type (keyboard, COM port, etc.).

Product	Interface	PID (Hex)	PID (Dec)
NVH220	USB HID Keyboard	1E22	7714
	USB CDC	1E06	7686
	USB HID-POS	1E10	7696

Chapter 6 Ethernet Interface

Introduction

NVH220 (Ethernet version) supports TCP/IP protocol. Scan below barcode to enable Ethernet communication.



@INTERF13

Ethernet

Device IP configuration

Confirm that the communication interface is set to Ethernet.

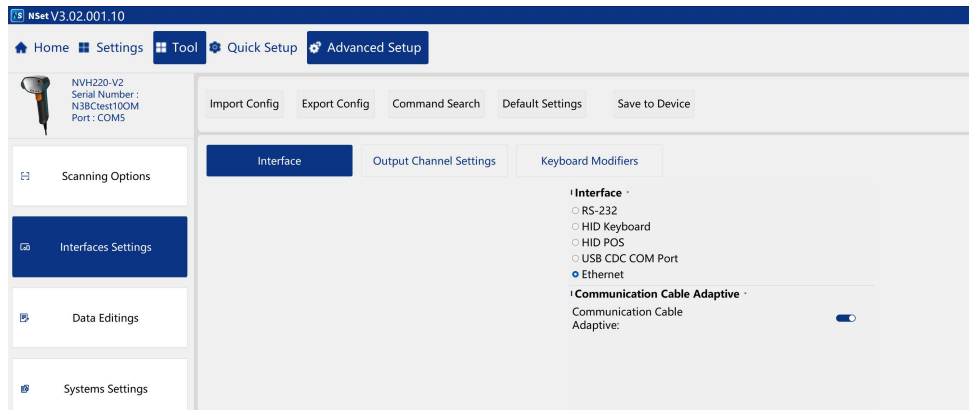

Then on the main interface of NSet, click network settings to set the fixed IP or DHCP (automatically obtain IP), as shown below.

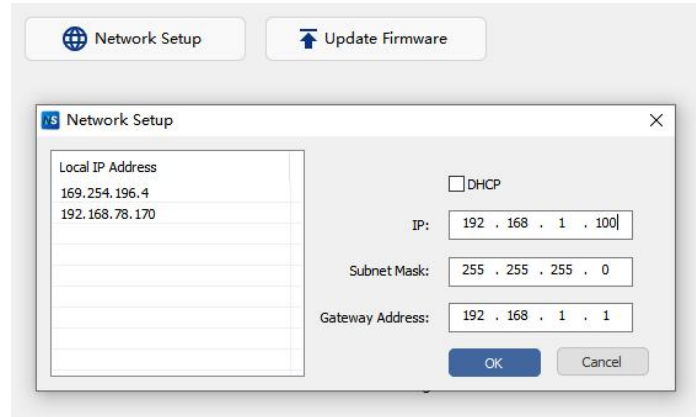

Check DHCP, and then click OK to use DHCP mode to obtain IP. If DHCP is not checked, it means that a fixed IP is used. Then, you need to configure the IP address, subnet mask, and gateway address in the above figure, and then click OK.

If need to reset the Ethernet IP, scan the NETDEF setup barcode to restore the default Ethernet settings. If use a non-Ethernet communication interface (such as USB or serial) enter the NETDEF command in the command center to restore the default Ethernet settings.

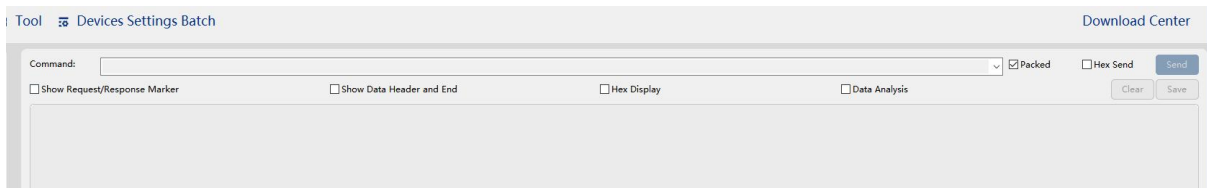

Ethernet IP Settings:

The default configuration of the Ethernet IP is:

IP: 192.168.1.100

Subnet mask: 255.255.255.0

Gateway 192.168.1.1

Ethernet Output Channel

TCP Server

Turn on the function of TCP server and transfer the barcode information to the remote client.

TCP Client

Transfer barcode data to remote TCP server through TCP client. You need to fill in the remote TCP server ip address in Nset.

The screenshot shows a configuration window with two sections: TCP Server and TCP Client. The TCP Server section includes a toggle for 'TCP Server' (turned on), a dropdown for 'Maximum number of TCP server connections' (set to 10), a dropdown for 'TCP Server Port' (set to 30000), and a toggle for 'TCP Output Channel Keepalived' (turned on). The TCP Client section includes a toggle for 'TCP Client' (turned on), a text input for 'Remote IP Address' (set to 192 . 168 . 1 . 200), and a dropdown for 'Remote Port' (set to 10000).



@BOCTSV0

****Disable TCP Server Output**



@BOCTSV1

Enable TCP Server Output



@BOCTCE0

Disable TCP Client Output



@BOCTCE1

Enable TCP Client Output

Chapter 7 Symbologies

Introduction

Every symbology (barcode type) has its own unique attributes. This chapter provides programming barcodes for configuring the scanner so that it can identify various symbologies. It is recommended to disable those that are rarely used to increase the efficiency of the scanner.

Global Settings

Enable/Disable All Symbologies

If the **Disable All Symbologies** feature is enabled, the scanner will not be able to read any non-programming barcodes except the programming barcodes.



@ALLENA1

Enable All Symbologies



@ALLENA0

Disable All Symbologies

Enable/Disable 1D Symbologies



@ALL1DC1

Enable 1D Symbologies



@ALL1DC0

Disable 1D Symbologies

Enable/Disable 2D Symbologies



@ALL2DC1

Enable 2D Symbologies



@ALL2DC0

Disable 2D Symbologies

1D Inverse



@CCF1IV0

Regular



@CCF1IV2

****Regular and Inverse**



@CCF1IV1

Inverse

Surround GS1 Application Identifiers (AIs) with Parentheses

When **Surround GS1 AIs with Parentheses** is selected, each application identifier (AI) contained in scanned data will be enclosed in parentheses in the output message.



@GS1AIP0

Do Not Surround GS1 AIs with Parentheses



@GS1AIP1

** Surround GS1 AIs with Parentheses

E
xample

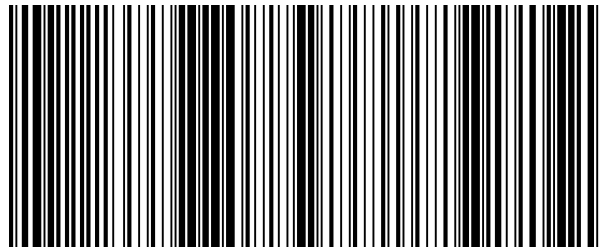

(01) 0 0614141 99999 6 (10) 10ABCEDF123456

If **Surround GS1 AIs with Parentheses** is selected, the barcode above is output as

(01)00614141999996(10)10ABCEDF123456.

If **Do Not Surround GS1 AIs with Parentheses** is selected, the barcode above is output as

01006141419999961010ABCEDF123456.

Output GS1 Application Identifiers (AIs)



@GS10AI0

Do Not Output GS1 AIs



@GS10AI1

**** Output GS1 AIs**

E
xample

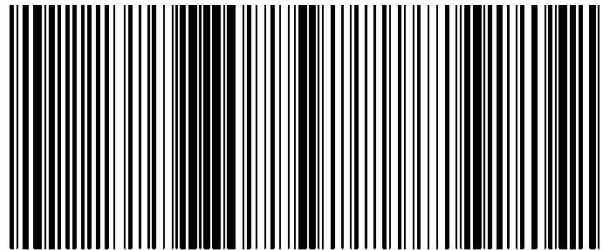

(01) 0 0614141 99999 6 (10) 10ABCEDF123456

If **Output GS1 AIs** is selected, the barcode above is output as 01006141419999961010ABCEDF123456

If **Do Not Output GS1 AIs** is selected, the barcode above is output as 0061414199999610ABCEDF123456

GS1-128(UCC/EAN-128)



@GS10A10
Do Not Output GS1 AIs



@GS10A11
**** Output GS1 AIs**

GS1 Composite



@GS10AC0
Do Not Output GS1 AIs



@GS10AC1
**** Output GS1 AIs**

GS1 QR



@GS10AQ0

Do Not Output GS1 AIs



@GS10AQ1

** Output GS1 AIs

GS1 Data Matrix



@GS10AD0

Do Not Output GS1 AIs



@GS10AD1

** Output GS1 AIs

Code 11

Restore Factory Defaults



@C11DEF

Restore the Factory Defaults of Code 11

Enable/Disable Code 11



@C11ENA1

Enable Code 11



@C11ENA0

**** Disable Code 11**



If the scanner fails to identify Code 11 barcodes, you may first try this solution by scanning the **Enter Setup** barcode and then **Enable Code 11** barcode.

Set Length Range for Code 11

The scanner can be configured to only decode Code 11 barcodes with lengths that fall between (inclusive) the minimum and maximum lengths. To accomplish it, you need to set the minimum and maximum lengths.



@C11MIN

Set the Minimum Length (Default: 1)



@C11MAX

Set the Maximum Length (Default: 128)



If minimum length is set to be greater than maximum length, the scanner only decodes Code 11 barcodes with either the minimum or maximum length. If minimum length is same as maximum length, only Code 11 barcodes with that length are to be decoded.



Set the scanner to decode Code 11 barcodes containing between 8 and 12 characters:

1. Scan the **Set the Minimum Length** barcode.
2. Scan the numeric barcode "8" from the "Digit Barcodes" section in Appendix.
3. Scan the **Save** barcode from the "Save/Cancel Barcodes" section in Appendix.
4. Scan the **Set the Maximum Length** barcode.
5. Scan the numeric barcodes "1" and "2" from the "Digit Barcodes" section in Appendix.
6. Scan the **Save** barcode from the "Save/Cancel Barcodes" section in Appendix.

Check Character Verification

Check characters are optional for Code 11 and can be added as the last one or two characters, which are calculated values used to verify the integrity of the data.

If the **Disable** option is enabled, the scanner transmits Code 11 barcodes as is.



@C11CHK0
**** Disable**



@C11CHK1
**** One Check Character, MOD11**



@C11CHK2
Two Check Characters, MOD11/MOD11



@C11CHK3
Two Check Characters, MOD11/MOD9



@C11CHK4
**One Check Character, MOD11 (Len<=10)
Two Check Characters, MOD11/MOD11(Len>10)**



@C11CHK5

One Check Character, MOD11 (Len<=10)
Two Check Characters, MOD11/MOD9 (Len>10)

Transmit Check Character



@C11TCK0

Do Not Transmit Code 11 Check Character



@C11TCK1

**** Transmit Code 11 Check Character**



If you select a check character algorithm and the **Do Not Transmit Check Character** option, Code 11 barcodes with a length that is less than the configured minimum length after having the check character(s) excluded will not be decoded. (For example, when the **One Check Character, MOD11** and **Do Not Transmit Check Character** options are enabled and the minimum length is set to 4, Code 11 barcodes with a total length of 4 characters including the check character cannot be read.)

Security Level



@C11SEC0

**** Set Security Level 1**



@C11SEC1

Set Security Level 2



@C11SEC2

Set Security Level 3



@C11SEC3

Set Security Level 4

Code 128

Restore Factory Defaults



@128DEF

Restore the Factory Defaults of Code 128

Enable/Disable Code 128



@128ENA1

**** Enable Code 128**



@128ENA0

Disable Code 128



If the scanner fails to identify Code 128 barcodes, you may first try this solution by scanning the **Enable Code 128** barcode.

Set Length Range for Code 128

The scanner can be configured to only decode Code 128 barcodes with lengths that fall between (inclusive) the minimum and maximum lengths. To accomplish it, you need to set the minimum and maximum lengths.



@128MIN

Set the Minimum Length (Default: 1)



@128MAX

Set the Maximum Length (Default: 48)



If minimum length is set to be greater than maximum length, the scanner only decodes Code 128 barcodes with either the minimum or maximum length. If minimum length is same as maximum length, only Code 128 barcodes with that length are to be decoded.



Set the scanner to decode Code 128 barcodes containing between 8 and 12 characters:

1. Scan the **Set the Minimum Length** barcode.
2. Scan the numeric barcode "8" from the "Digit Barcodes" section in Appendix.
3. Scan the **Save** barcode from the "Save/Cancel Barcodes" section in Appendix.
4. Scan the **Set the Maximum Length** barcode.
5. Scan the numeric barcodes "1" and "2" from the "Digit Barcodes" section in Appendix.
6. Scan the **Save** barcode from the "Save/Cancel Barcodes" section in Appendix.

Security Level



@128ESC0

**** Set Security Level 1**



@128ESC1

Set Security Level 2



@128ESC2

Set Security Level 3



@128ESC3

Set Security Level 4

Code 39

Restore Factory Defaults



@C39DEF

Restore the Factory Defaults of Code 39

Enable/Disable Code 39



@C39ENA1

**** Enable Code 39**



@C39ENA0

Disable Code 39



If the scanner fails to identify Code 39 barcodes, you may first try this solution by scanning the **Enable Code 39** barcode.

Set Length Range for Code 39

The scanner can be configured to only decode Code 39 barcodes with lengths that fall between (inclusive) the minimum and maximum lengths. To accomplish it, you need to set the minimum and maximum lengths.



@C39MIN

Set the Minimum Length (Default: 1)



@C39MAX

Set the Maximum Length (Default: 48)



If minimum length is set to be greater than maximum length, the scanner only decodes Code 39 barcodes with either the minimum or maximum length. If minimum length is same as maximum length, only Code 39 barcodes with that length are to be decoded.



Set the scanner to decode Code 39 barcodes containing between 8 and 12 characters:

1. Scan the **Set the Minimum Length** barcode.
2. Scan the numeric barcode “8” from the “Digit Barcodes” section in Appendix.
3. Scan the **Save** barcode from the “Save/Cancel Barcodes” section in Appendix.
4. Scan the **Set the Maximum Length** barcode.
5. Scan the numeric barcodes “1” and “2” from the “Digit Barcodes” section in Appendix.
6. Scan the **Save** barcode from the “Save/Cancel Barcodes” section in Appendix.

Check Character Verification

A check character is optional for Code 39 and can be added as the last character. It is a calculated value used to verify the integrity of the data.

- ✧ **Disable:** The scanner transmits Code 39 barcodes as is.
- ✧ **Do Not Transmit Check Character After Verification:** The scanner checks the integrity of all Code 39 barcodes to verify that the data complies with the check character algorithm. Barcodes passing the check will be transmitted except the last digit, whereas those failing it will not be transmitted.
- ✧ **Transmit Check Character After Verification:** The scanner checks the integrity of all Code 39 barcodes to verify that the data complies with the check character algorithm. Barcodes passing the check will be transmitted, whereas those failing it will not be transmitted.



@C39CHK0

** Disable



@C39CHK1

Do Not Transmit Check Character After Verification



@C39CHK2

Transmit Check Character After Verification



If the **Do Not Transmit Check Character After Verification** option is enabled, Code 39 barcodes with a length that is less than the configured minimum length after having the check character excluded will not be decoded. (For example, when the **Do Not Transmit Check Character After Verification** option is enabled and the minimum length is set to 4, Code 39 barcodes with a total length of 4 characters including the check character cannot be read.)

Transmit Start/Stop Character

Code 39 uses an asterisk (*) for both the start and the stop characters. You can choose whether or not to transmit the start/stop characters by scanning the appropriate barcode below.



@C39TSC0

**** Do Not Transmit Start/Stop Character**



@C39TSC1

Transmit Start/Stop Character

Enable/Disable Code 39 Full ASCII

The scanner can be configured to identify all ASCII characters by scanning the appropriate barcode below.



@C39ASC0

**** Disable Code 39 Full ASCII**



@C39ASC1

Enable Code 39 Full ASCII

Enable/Disable Code 32 (Italian Pharma Code)

Code 32 is a variant of Code 39 used by the Italian pharmaceutical industry. Scan the appropriate bar code below to enable or disable Code 32. Code 39 must be enabled and Code 39 check character verification must be disabled for this parameter to function.



@C39E320

**** Disable Code 32**



@C39E321

Enable Code 32

Code 32 Prefix

Scan the appropriate barcode below to enable or disable adding the prefix character "A" to all Code 32 barcodes. Code 32 must be enabled for this parameter to function.



@C39S320

**** Disable Code 32 Prefix**



@C39S321

Enable Code 32 Prefix

Transmit Code 32 Start/Stop Character

Code 32 must be enabled for this parameter to function.



@C39T320

**** Do Not Transmit Code 32
Start/Stop Character**



@C39T321

Transmit Code 32 Start/Stop Character

Transmit Code 32 Check Character

Code 32 must be enabled for this parameter to function.



@C39C320

**** Do Not Transmit Code 32 Check
Character**



@C39C321

Transmit Code 32 Check Character

Security Level



@C39SEC0

**** Set Security Level 1**



@C39SEC1

Set Security Level 2



@C39SEC2

Set Security Level 3



@C39SEC3

Set Security Level 4

GS1-128 (UCC/EAN-128)

Restore Factory Defaults



@GS1DEF

Restore the Factory Defaults of GS1-128

Enable/Disable GS1-128



@GS1ENA1

**** Enable GS1-128**



@GS1ENA0

****Disable GS1-128**



If the scanner fails to identify GS1-128 barcodes, you may first try this solution by scanning the **Enable GS1-128** barcode.

Set Length Range for GS1-128

The scanner can be configured to only decode GS1-128 barcodes with lengths that fall between (inclusive) the minimum and maximum lengths. To accomplish it, you need to set the minimum and maximum lengths.



@GS1MIN

Set the Minimum Length (Default: 1)



@GS1MAX

Set the Maximum Length (Default: 128)



If minimum length is set to be greater than maximum length, the scanner only decodes GS1-128 barcodes with either the minimum or maximum length. If minimum length is same as maximum length, only GS1-128 barcodes with that length are to be decoded.



Set the scanner to decode GS1-128 barcodes containing between 8 and 12 characters:

7. Scan the **Set the Minimum Length** barcode.
8. Scan the numeric barcode “8” from the “Digit Barcodes” section in Appendix.
9. Scan the **Save** barcode from the “Save/Cancel Barcodes” section in Appendix.
10. Scan the **Set the Maximum Length** barcode.
11. Scan the numeric barcodes “1” and “2” from the “Digit Barcodes” section in Appendix.
12. Scan the **Save** barcode from the “Save/Cancel Barcodes” section in Appendix.

Security Level



@GS1SEC0

****Set Security Level 1**



@GS1SEC1

Set Security Level 2



@GS1SEC2

Set Security Level 3



@GS1SEC3

Set Security Level 4

GS1 Composite (EAN·UCC Composite)

Restore Factory Defaults



@CPTDEF

**** Restore the Factory Defaults of GS1 Composite**

Enable/Disable GS1 Composite



@CPTENA1

Enable GS1 Composite



@CPTENA0

**** Disable GS1 Composite**



If the scanner fails to identify GS1 Composite barcodes, you may first try this solution by scanning the **Enter Setup** barcode and then **Enable GS1 Composite** barcode.

Enable/Disable UPC/EAN Composite



@CPTUPC0

**** Disable UPC/EAN Composite**



@CPTUPC1

Enable UPC/EAN Composite

Output 1D Barcode Only



@CPTOOD0

**** Disable**



@CPTOOD1

Enable

Security Level



@CPTSEC0

****Set Security Level 1**



@CPTSEC1

Set Security Level 2



@CPTSEC2

Set Security Level 3



@CPTSEC3

Set Security Level 4

AIM 128

Restore Factory Defaults



@AIMDEF

Restore the Factory Defaults of AIM 128

Enable/Disable AIM 128



@AIMENA1

Enable AIM128



@AIMENA0

**** Disable AIM 128**



If the scanner fails to identify AIM 128 barcodes, you may first try this solution by scanning the **Enable AIM 128** barcode.

Set Length Range for AIM 128

The scanner can be configured to only decode AIM 128 barcodes with lengths that fall between (inclusive) the minimum and maximum lengths. To accomplish it, you need to set the minimum and maximum lengths.



@AIMMIN

Set the Minimum Length (Default: 1)



@AIMMAX

Set the Maximum Length (Default: 48)



If minimum length is set to be greater than maximum length, the scanner only decodes GS1-128 barcodes with either the minimum or maximum length. If minimum length is same as maximum length, only GS1-128 barcodes with that length are to be decoded.



Set the scanner to decode AIM 128 barcodes containing between 8 and 12 characters:

1. Scan the **Set the Minimum Length** barcode.
2. Scan the numeric barcode “8” from the “Digit Barcodes” section in Appendix.
3. Scan the **Save** barcode from the “Save/Cancel Barcodes” section in Appendix.
4. Scan the **Set the Maximum Length** barcode.
5. Scan the numeric barcodes “1” and “2” from the “Digit Barcodes” section in Appendix.
6. Scan the **Save** barcode from the “Save/Cancel Barcodes” section in Appendix.

Security Level



@AIMSEC0

****Set Security Level 1**



@AIMSEC1

Set Security Level 2



@AIMSEC2

Set Security Level 3



@AIMSEC3

Set Security Level 4

ISBT 128

Restore Factory Defaults



@BTDEF

Restore the Factory Defaults of ISBT 128

Enable/Disable ISBT 128



@IBTENA1

Enable ISBT 128



@IBTENA0

** Disable ISBT 128



If the scanner fails to identify ISBT-128 barcodes, you may first try this solution by scanning the **Enable ISBT-128** barcode.

Security Level



@IBTSEC0

****Set Security Level 1**



@IBTSEC1

Set Security Level 2



@IBTSEC2

Set Security Level 3



@IBTSEC3

Set Security Level 4

Codabar

Restore Factory Defaults



@CBADEF

Restore the Factory Defaults of Codabar

Enable/Disable Codabar



@CBAENA1

**** Enable Codabar**



@CBAENA0

Disable Codabar



If the scanner fails to identify Codabar barcodes, you may first try this solution by scanning the **Enable Codabar** barcode.

Set Length Range for Codabar

The scanner can be configured to only decode Codabar barcodes with lengths that fall between (inclusive) the minimum and maximum lengths. To accomplish it, you need to set the minimum and maximum lengths.



@CBAMIN

Set the Minimum Length (Default: 2)



@CBAMAX

Set the Maximum Length (Default: 60)



If minimum length is set to be greater than maximum length, the scanner only decodes Codabar barcodes with either the minimum or maximum length. If minimum length is same as maximum length, only Codabar barcodes with that length are to be decoded.



Set the scanner to decode Codabar barcodes containing between 8 and 12 characters:

1. Scan the **Set the Minimum Length** barcode.
2. Scan the numeric barcode "8" from the "Digit Barcodes" section in Appendix.
3. Scan the **Save** barcode from the "Save/Cancel Barcodes" section in Appendix.
4. Scan the **Set the Maximum Length** barcode.
5. Scan the numeric barcodes "1" and "2" from the "Digit Barcodes" section in Appendix.
6. Scan the **Save** barcode from the "Save/Cancel Barcodes" section in Appendix.

Check Character Verification

A check character is optional for Codabar and can be added as the last character. It is a calculated value used to verify the integrity of the data.

- ✧ **Disable:** The scanner transmits Codabar barcodes as is.
- ✧ **Do Not Transmit Check Character After Verification:** The scanner checks the integrity of all Codabar barcodes to verify that the data complies with the check character algorithm. Barcodes passing the check will be transmitted except the last digit, whereas those failing it will not be transmitted.
- ✧ **Transmit Check Character After Verification:** The scanner checks the integrity of all Codabar barcodes to verify that the data complies with the check character algorithm. Barcodes passing the check will be transmitted, whereas those failing it will not be transmitted.



@CBACHK0

** Disable



@CBACHK1

Do Not Transmit Check Character After Verification



@CBACHK2

Transmit Check Character After Verification



If the **Do Not Transmit Check Character After Verification** option is enabled, Codabar barcodes with a length that is less than the configured minimum length after having the check character excluded will not be decoded. (For example, when the **Do Not Transmit Check Character After Verification** option is enabled and the minimum length is set to 4, Codabar barcodes with a total length of 4 characters including the check character cannot be read.)

Start/Stop Character

You can set the start/stop characters and choose whether or not to transmit the start/stop characters by scanning the appropriate barcode below.



@CBATSC0

**** Do Not Transmit Start/Stop Character**



@CBATSC1

Transmit Start/Stop Character



@CBASCF0

**** ABCD/ABCD as the Start/Stop Character**



@CBASCF1

ABCD/TN*E as the Start/Stop Character



@CBASCF2

abcd/abcd as the Start/Stop Character



@CBASCF3

abcd/tn*e as the Start/Stop Character

Security Level



@CBASEC0

****Set Security Level 1**



@CBASEC1

Set Security Level 2



@CBASEC2

Set Security Level 3



@CBASEC3

Set Security Level 4

Code 93

Restore Factory Defaults



@C93DEF

Restore the Factory Defaults of Code 93

Enable/Disable Code 93



@C93ENA1

****Enable Code 93**



@C93ENA0

**** Disable Code 93**



If the scanner fails to identify Code 93 barcodes, you may first try this solution by scanning the **Enable Code 93** barcode.

Set Length Range for Code 93

The scanner can be configured to only decode Code 93 barcodes with lengths that fall between (inclusive) the minimum and maximum lengths. To accomplish it, you need to set the minimum and maximum lengths.



@C93MIN

Set the Minimum Length (Default: 1)



@C93MAX

Set the Maximum Length (Default: 48)



If minimum length is set to be greater than maximum length, the scanner only decodes Code 93 barcodes with either the minimum or maximum length. If minimum length is same as maximum length, only Code 93 barcodes with that length are to be decoded.



Set the scanner to decode Code 93 barcodes containing between 8 and 12 characters:

1. Scan the **Set the Minimum Length** barcode.
2. Scan the numeric barcode "8" from the "Digit Barcodes" section in Appendix.
3. Scan the **Save** barcode from the "Save/Cancel Barcodes" section in Appendix.
4. Scan the **Set the Maximum Length** barcode.
5. Scan the numeric barcodes "1" and "2" from the "Digit Barcodes" section in Appendix.
6. Scan the **Save** barcode from the "Save/Cancel Barcodes" section in Appendix.

Security Level



@C93SEC0

****Set Security Level 1**



@C93SEC1

Set Security Level 2



@C93SEC2

Set Security Level 3



@C93SEC3

Set Security Level 4

UPC-A

Restore Factory Defaults



@UPADEF

Restore the Factory Defaults of UPC-A

Enable/Disable UPC-A



@UPAENA1

**** Enable UPC-A**



@UPAENA0

Disable UPC-A



If the scanner fails to identify UPC-A barcodes, you may first try this solution by scanning the **Enable UPC-A** barcode.

Transmit Check Character

UPC-A is 13 digits in length with the last one as its check character used to verify the integrity of the data.



@UPACHK2

**** Transmit UPC-A Check Character**



@UPACHK1

Do Not Transmit UPC-A Check Character

2-Digit Add-On Code

A UPC-A barcode can be augmented with a two-digit add-on code to form a new one. In the example below, the part surrounded by blue dotted line is a UPC-A barcode while the part circled by red dotted line is a two-digit add-on code.



@UPAAD20

**** Disable 2-Digit Add-On Code**



@UPAAD21

Enable 2-Digit Add-On Code



Disable 2-Digit Add-On Code: The scanner decodes UPC-A and ignores the add-on code when presented with a UPC-A plus 2-digit add-on barcode. It can also decode UPC-A barcodes without 2-digit add-on codes.

Enable 2-Digit Add-On Code: The scanner decodes a mix of UPC-A barcodes with and without 2-digit add-on codes.

5-Digit Add-On Code

A UPC-A barcode can be augmented with a five-digit add-on code to form a new one. In the example below, the part surrounded by blue dotted line is a UPC-A barcode while the part circled by red dotted line is a five-digit add-on code.



@UPAAD50

**** Disable 5-Digit Add-On Code**



@UPAAD51

Enable 5-Digit Add-On Code



Disable 5-Digit Add-On Code: The scanner decodes UPC-A and ignores the add-on code when presented with a UPC-A plus 5-digit add-on barcode. It can also decode UPC-A barcodes without 5-digit add-on codes.

Enable 5-Digit Add-On Code: The scanner decodes a mix of UPC-A barcodes with and without 5-digit add-on codes.

Add-On Code Required

When **UPC-A Add-On Code Required** is selected, the scanner will only read UPC-A barcodes that contain add-on codes.



@UPAREQ1

UPC-A Add-On Code Required



@UPAREQ0

**** UPC-A Add-On Code Not Required**

Transmit Preamble Character

Preamble characters (Country Code and System Character) can be transmitted as part of a UPC-A barcode. Select one of the following options for transmitting UPC-A preamble to the host device: transmit system character only, transmit system character and country code ("0" for USA), or transmit no preamble.



@UPAPRE0

No Preamble



@UPAPRE1

**** System Character**



@UPAPRE2

System Character & Country Code

Security Level



@UPASEC0

****Set Security Level 1**



@UPASEC1

Set Security Level 2



@UPASEC2

Set Security Level 3



@UPASEC3

Set Security Level 4

UPC-E

Restore Factory Defaults



@UPEDEF

Restore the Factory Defaults of UPC-E

Enable/Disable UPC-E



@UPEENA1

**** Enable UPC-E**



@UPEENA0

Disable UPC-E

Transmit Check Character

UPC-E is 8 digits in length with the last one as its check character used to verify the integrity of the data.



@UPECHK2

**** Transmit UPC-E Check Character**



@UPECHK1

Do Not Transmit UPC-E Check Character

2-Digit Add-On Code

A UPC-E barcode can be augmented with a two-digit add-on code to form a new one. In the example below, the part surrounded by blue dotted line is a UPC-E barcode while the part circled by red dotted line is a two-digit add-on code.



@UPEAD20

**** Disable 2-Digit Add-On Code**



@UPEAD21

Enable 2-Digit Add-On Code



Disable 2-Digit Add-On Code: The scanner decodes UPC-E and ignores the add-on code when presented with a UPC-E plus 2-digit add-on barcode. It can also decode UPC-E barcodes without 2-digit add-on codes.

Enable 2-Digit Add-On Code: The scanner decodes a mix of UPC-E barcodes with and without 2-digit add-on codes.

5-Digit Add-On Code

A UPC-E barcode can be augmented with a five-digit add-on code to form a new one. In the example below, the part surrounded by blue dotted line is a UPC-E barcode while the part circled by red dotted line is a five-digit add-on code.



@UPEAD50

**** Disable 5-Digit Add-On Code**



@UPEAD51

Enable 5-Digit Add-On Code



Disable 5-Digit Add-On Code: The scanner decodes UPC-E and ignores the add-on code when presented with a UPC-E plus 5-digit add-on barcode. It can also decode UPC-E barcodes without 5-digit add-on codes.

Enable 5-Digit Add-On Code: The scanner decodes a mix of UPC-E barcodes with and without 5-digit add-on codes.

Add-On Code Required

When **UPC-E Add-On Code Required** is selected, the scanner will only read UPC-E barcodes that contain add-on codes.



@UPEREQ1

UPC-E Add-On Code Required



@UPEREQ0

**** UPC-E Add-On Code Not Required**

Transmit Preamble Character

Preamble characters (Country Code and System Character) can be transmitted as part of a UPC-E barcode. Select one of the following options for transmitting UPC-E preamble to the host device: transmit system character only, transmit system character and country code ("0" for USA), or transmit no preamble.



@UPEPRE1

**** System Character**



@UPEPRE0

No Preamble



@UPEPRE2

System Character & Country Code

UPC-E0



@UPEEN00

Disable UPC-E0



@UPEEN01

****Enable UPC-E0**

UPC-E1



@UPEEN10

Disable UPC-E1



@UPEEN11

****Enable UPC-E1**

Security Level



@UPESEC0

****Set Security Level 1**



@UPESEC1

Set Security Level 2



@UPESEC2

Set Security Level 3



@UPESEC3

Set Security Level 4

EAN-8

Restore Factory Defaults



@EA8DEF

Restore the Factory Defaults of EAN-8

Enable/Disable EAN-8



@EA8ENA1

**** Enable EAN-8**



@EA8ENA0

Disable EAN-8



If the scanner fails to identify EAN-8 barcodes, you may first try this solution by scanning the **Enable EAN-8** barcode.

Transmit Check Character

EAN-8 is 8 digits in length with the last one as its check character used to verify the integrity of the data.



@EA8CHK2

**** Transmit EAN-8 Check Character**



@EA8CHK1

Do Not Transmit EAN-8 Check Character

2-Digit Add-On Code

An EAN-8 barcode can be augmented with a two-digit add-on code to form a new one. In the example below, the part surrounded by blue dotted line is an EAN-8 barcode while the part circled by red dotted line is a two-digit add-on code.



@EA8AD20

**** Disable 2-Digit Add-On Code**



@EA8AD21

Enable 2-Digit Add-On Code



Disable 2-Digit Add-On Code: The scanner decodes EAN-8 and ignores the add-on code when presented with an EAN-8 plus 2-digit add-on barcode. It can also decode EAN-8 barcodes without 2-digit add-on codes.

Enable 2-Digit Add-On Code: The scanner decodes a mix of EAN-8 barcodes with and without 2-digit add-on codes.

5-Digit Add-On Code

An EAN-8 barcode can be augmented with a five-digit add-on code to form a new one. In the example below, the part surrounded by blue dotted line is an EAN-8 barcode while the part circled by red dotted line is a five-digit add-on code.



@EA8AD50

**** Disable 5-Digit Add-On Code**



@EA8AD51

Enable 5-Digit Add-On Code



Disable 5-Digit Add-On Code: The scanner decodes EAN-8 and ignores the add-on code when presented with an EAN-8 plus 5-digit add-on barcode. It can also decode EAN-8 barcodes without 5-digit add-on codes.

Enable 5-Digit Add-On Code: The scanner decodes a mix of EAN-8 barcodes with and without 5-digit add-on codes.

Add-On Code Required

When **EAN-8 Add-On Code Required** is selected, the scanner will only read EAN-8 barcodes that contain add-on codes.



@EA8REQ1

EAN-8 Add-On Code Required



@EA8REQ0

**** EAN-8 Add-On Code Not Required**

Security Level



@EA8SEC0

****Set Security Level 1**



@EA8SEC1

Set Security Level 2



@EA8SEC2

Set Security Level 3



@EA8SEC3

Set Security Level 4

EAN-13

Restore Factory Defaults



@E13DEF

Restore the Factory Defaults of EAN-13

Enable/Disable EAN-13



@E13ENA1

**** Enable EAN-13**



@E13ENA0

Disable EAN-13



If the scanner fails to identify EAN-13 barcodes, you may first try this solution by scanning the **Enable EAN-13** barcode.

Transmit Check Character



@E13CHK2

**** Transmit EAN-13 Check Character**



@E13CHK1

Do Not Transmit EAN-13 Check Character

2-Digit Add-On Code

An EAN-13 barcode can be augmented with a two-digit add-on code to form a new one. In the example below, the part surrounded by blue dotted line is an EAN-13 barcode while the part circled by red dotted line is a two-digit add-on code.



@E13AD20

**** Disable 2-Digit Add-On Code**



@E13AD21

Enable 2-Digit Add-On Code



Disable 2-Digit Add-On Code: The scanner decodes EAN-13 and ignores the add-on code when presented with an EAN-13 plus 2-digit add-on barcode. It can also decode EAN-13 barcodes without 2-digit add-on codes.

Enable 2-Digit Add-On Code: The scanner decodes a mix of EAN-13 barcodes with and without 2-digit add-on codes.

5-Digit Add-On Code

An EAN-13 barcode can be augmented with a five-digit add-on code to form a new one. In the example below, the part surrounded by blue dotted line is an EAN-13 barcode while the part circled by red dotted line is a five-digit add-on code.



@E13AD50

**** Disable 5-Digit Add-On Code**



@E13AD51

Enable 5-Digit Add-On Code



Disable 5-Digit Add-On Code: The scanner decodes EAN-13 and ignores the add-on code when presented with an EAN-13 plus 5-digit add-on barcode. It can also decode EAN-13 barcodes without 5-digit add-on codes.

Enable 5-Digit Add-On Code: The scanner decodes a mix of EAN-13 barcodes with and without 5-digit add-on codes.

Add-On Code Required

When **EAN-13 Add-On Code Required** is selected, the scanner will only read EAN-13 barcodes that contain add-on codes.



@E13REQ0

**** EAN-13 Add-On Code Not Required**



@E13REQ1

EAN-13 Add-On Code Required

Security Level



@E13SEC0

****Set Security Level 1**



@E13SEC1

Set Security Level 2



@E13SEC2

Set Security Level 3



@E13SEC3

Set Security Level 4

ISSN

Restore Factory Defaults



@ISSDEF

Restore the Factory Defaults of ISSN

Enable/Disable ISSN



@ISSENA1

Enable ISSN



@ISSENA0

**** Disable ISSN**

Security Level



@ISSSEC0

****Set Security Level 1**



@ISSSEC1

Set Security Level 2



@ISSSEC2

Set Security Level 3



@ISSSEC3

Set Security Level 4

Interleaved 2 of 5

Restore Factory Defaults



@I25DEF

Restore the Factory Defaults of Interleaved 2 of 5

Enable/Disable Interleaved 2 of 5



@I25ENA1

Enable Interleaved 2 of 5



@I25ENA0

****Disable Interleaved 2 of 5**



If the scanner fails to identify Interleaved 2 of 5 barcodes, you may first try this solution by scanning the **Enable Interleaved 2 of 5** barcode.

Set Length Range for Interleaved 2 of 5

The scanner can be configured to only decode Interleaved 2 of 5 barcodes with lengths that fall between (inclusive) the minimum and maximum lengths. To accomplish it, you need to set the minimum and maximum lengths.



@I25MIN

Set the Minimum Length (Default: 6)



@I25MAX

Set the Maximum Length (Default: 80)



If minimum length is set to be greater than maximum length, the scanner only decodes Interleaved 2 of 5 barcodes with either the minimum or maximum length. If minimum length is same as maximum length, only Interleaved 2 of 5 barcodes with that length are to be decoded.

E *sample*

Set the scanner to decode Interleaved 2 of 5 barcodes containing between 8 and 12 characters:

1. Scan the **Set the Minimum Length** barcode.
2. Scan the numeric barcode "8" from the "Digit Barcodes" section in Appendix.
3. Scan the **Save** barcode from the "Save/Cancel Barcodes" section in Appendix.
4. Scan the **Set the Maximum Length** barcode.
5. Scan the numeric barcodes "1" and "2" from the "Digit Barcodes" section in Appendix.
6. Scan the **Save** barcode from the "Save/Cancel Barcodes" section in Appendix.

Check Character Verification

A check character is optional for Interleaved 2 of 5 and can be added as the last character. It is a calculated value used to verify the integrity of the data.

- ✧ **Disable:** The scanner transmits Interleaved 2 of 5 barcodes as is.
- ✧ **Do Not Transmit Check Character After Verification:** The scanner checks the integrity of all Interleaved 2 of 5 barcodes to verify that the data complies with the check character algorithm. Barcodes passing the check will be transmitted except the last digit, whereas those failing it will not be transmitted.
- ✧ **Transmit Check Character After Verification:** The scanner checks the integrity of all Interleaved 2 of 5 barcodes to verify that the data complies with the check character algorithm. Barcodes passing the check will be transmitted, whereas those failing it will not be transmitted.

Since Interleaved 2 of 5 must always have an even number of digits, a zero may need to be added as the first digit when the check character is added. The check character is automatically generated when making Interleaved 2 of 5 barcodes.



@I25CHK0

**** Disable**



@I25CHK1

Do Not Transmit Check Character After Verification



@I25CHK2

Transmit Check Character After Verification



If the **Do Not Transmit Check Character After Verification** option is enabled, Interleaved 2 of 5 barcodes with a length that is less than the configured minimum length after having the check character excluded will not be decoded. (For example, when the **Do Not Transmit Check Character After Verification** option is enabled and the minimum length is set to 4, Interleaved 2 of 5 barcodes with a total length of 4 characters including the check character cannot be read.)

Febraban



@I25FBB0

**** Disable Febraban**



@I25FBB1

Enable Febraban, Do Not Expand



@I25FBB2

Enable Febraban, Expand

Security Level



@I25SEC0

****Set Security Level 1**



@I25SEC1

Set Security Level 2



@I25SEC2

Set Security Level 3



@I25SEC3

Set Security Level 4

Matrix 2 of 5

Restore Factory Defaults



@M25DEF

Restore the Factory Defaults of Matrix 2 of 5

Enable/Disable Matrix 2 of 5



@M25ENA1

**** Enable Matrix 2 of 5**



@M25ENA0

Disable Matrix 2 of 5



If the scanner fails to identify Matrix 2 of 5 barcodes, you may first try this solution by scanning the **Enable Matrix 2 of 5** barcode.

Set Length Range for Matrix 2 of 5

The scanner can be configured to only decode Matrix 2 of 5 barcodes with lengths that fall between (inclusive) the minimum and maximum lengths. To accomplish it, you need to set the minimum and maximum lengths.



@M25MIN

Set the Minimum Length (Default: 1)



@M25MAX

Set the Maximum Length (Default: 128)



If minimum length is set to be greater than maximum length, the scanner only decodes Matrix 2 of 5 barcodes with either the minimum or maximum length. If minimum length is same as maximum length, only Matrix 2 of 5 barcodes with that length are to be decoded.



Set the scanner to decode Matrix 2 of 5 barcodes containing between 8 and 12 characters:

1. Scan the **Set the Minimum Length** barcode.
2. Scan the numeric barcode "8" from the "Digit Barcodes" section in Appendix.
3. Scan the **Save** barcode from the "Save/Cancel Barcodes" section in Appendix.
4. Scan the **Set the Maximum Length** barcode.
5. Scan the numeric barcodes "1" and "2" from the "Digit Barcodes" section in Appendix.
6. Scan the **Save** barcode from the "Save/Cancel Barcodes" section in Appendix.

Check Character Verification

A check character is optional for Matrix 2 of 5 and can be added as the last character. It is a calculated value used to verify the integrity of the data.

- ◇ **Disable:** The scanner transmits Matrix 2 of 5 barcodes as is.
- ◇ **Do Not Transmit Check Character After Verification:** The scanner checks the integrity of all Matrix 2 of 5 barcodes to verify that the data complies with the check character algorithm. Barcodes passing the check will be transmitted except the last digit, whereas those failing it will not be transmitted.
- ◇ **Transmit Check Character After Verification:** The scanner checks the integrity of all Matrix 2 of 5 barcodes to verify that the data complies with the check character algorithm. Barcodes passing the check will be transmitted, whereas those failing it will not be transmitted.

Since Matrix 2 of 5 must always have an even number of digits, a zero may need to be added as the first digit when the check character is added. The check character is automatically generated when making Matrix 2 of 5 barcodes.



@M25CHK0

**** Disable**



@M25CHK1

Do Not Transmit Check Character After Verification



@M25CHK2

Transmit Check Character After Verification



If the **Do Not Transmit Check Character After Verification** option is enabled, Matrix 2 of 5 barcodes with a length that is less than the configured minimum length after having the check character excluded will not be decoded. (For example, when the **Do Not Transmit Check Character After Verification** option is enabled and the minimum length is set to 4, Matrix 2 of 5 barcodes with a total length of 4 characters including the check character cannot be read.)

Security Level



@M25SEC0

****Set Security Level 1**



@M25SEC1

Set Security Level 2



@M25SEC2

Set Security Level 3



@M25SEC3

Set Security Level 4

Industrial 2/5

Restore Factory Defaults



@L25DEF

Restore the Factory Defaults of Industrial 25

Enable/Disable Industrial 2/5



@L25ENA1

Enable Industrial 2/5



@L25ENA0

**** Disable Industrial 2/5**



If the scanner fails to identify Industrial 2/5 barcodes, you may first try this solution by scanning the **Enable Industrial 2/5** barcode.

Set Length Range for Industrial 25

The scanner can be configured to only decode Industrial 25 barcodes with lengths that fall between (inclusive) the minimum and maximum lengths. To accomplish it, you need to set the minimum and maximum lengths.



@L25MIN

Set the Minimum Length (Default: 1)



@L25MAX

Set the Maximum Length (Default: 128)



If minimum length is set to be greater than maximum length, the scanner only decodes Industrial 25 barcodes with either the minimum or maximum length. If minimum length is same as maximum length, only Industrial 25 barcodes with that length are to be decoded.

Example

Set the scanner to decode Industrial 25 barcodes containing between 8 and 12 characters:

1. Scan the **Set the Minimum Length** barcode.
2. Scan the numeric barcode “8” from the “Digit Barcodes” section in Appendix.
3. Scan the **Save** barcode from the “Save/Cancel Barcodes” section in Appendix.
4. Scan the **Set the Maximum Length** barcode.
5. Scan the numeric barcodes “1” and “2” from the “Digit Barcodes” section in Appendix.
6. Scan the **Save** barcode from the “Save/Cancel Barcodes” section in Appendix.

Check Character Verification

A check character is optional for Industrial 25 and can be added as the last character. It is a calculated value used to verify the integrity of the data.

- ◇ **Disable:** The scanner transmits Industrial 25 barcodes as is.
- ◇ **Do Not Transmit Check Character After Verification:** The scanner checks the integrity of all Industrial 25 barcodes to verify that the data complies with the check character algorithm. Barcodes passing the check will be transmitted except the last digit, whereas those failing it will not be transmitted.
- ◇ **Transmit Check Character After Verification:** The scanner checks the integrity of all Industrial 25 barcodes to verify that the data complies with the check character algorithm. Barcodes passing the check will be transmitted, whereas those failing it will not be transmitted.



@L25CHK0

** Disable



@L25CHK1

Do Not Transmit Check Character After Verification



@L25CHK2

Transmit Check Character After Verification



If the **Do Not Transmit Check Character After Verification** option is enabled, Industrial 25 barcodes with a length that is less than the configured minimum length after having the check character excluded will not be decoded. (For example, when the **Do Not Transmit Check Character After Verification** option is enabled and the minimum length is set to 4, Industrial 25 barcodes with a total length of 4 characters including the check character cannot be read.)

Security Level



@L25SEC0

****Set Security Level 1**



@L25SEC1

Set Security Level 2



@L25SEC2

Set Security Level 3



@L25SEC3

Set Security Level 4

ITF-14

ITF-14 is a special kind of Interleaved 2 of 5 with a length of 14 characters and the last character as the check character.

ITF-14 priority principle: For the Interleaved 2 of 5 barcodes with a length of 14 characters and the last character as the check character, the ITF-14 configurations shall take precedence over the Interleaved 2 of 5 settings.

Restore Factory Defaults



@I14DEF

Restore the Factory Defaults of ITF-14

Enable/Disable ITF-14



@I14ENA0

**** Disable ITF-14**



@I14ENA1

Enable ITF-14 But Do Not Transmit Check Character



@I14ENA2

Enable ITF-14 and Transmit Check Character



An example of the ITF-14 priority principle: when ITF-14 is enabled and Interleaved 2 of 5 is disabled, the scanner only decodes Interleaved 2 of 5 barcodes with a length of 14 characters and the last character as the check character.

Security Level



@I14SEC0

****Set Security Level 1**



@ I14SEC1

Set Security Level 2



@ I14SEC2

Set Security Level 3



@ I14SEC3

Set Security Level 4

ITF-6

ITF-6 is a special kind of Interleaved 2 of 5 with a length of 6 characters and the last character as the check character.

ITF-6 priority principle: For the Interleaved 2 of 5 barcodes with a length of 6 characters and the last character as the check character, the ITF-6 configurations shall take precedence over the Interleaved 2 of 5 settings.

Restore Factory Defaults



@IT6DEF

Restore the Factory Defaults of ITF-6

Enable/Disable ITF-6



@IT6ENA0

**** Disable ITF-6**



@IT6ENA1

Enable ITF-6 But Do Not Transmit Check Character



@IT6ENA2

Enable ITF-6 and Transmit Check Character



An example of the ITF-6 priority principle: when ITF-6 is enabled and Interleaved 2 of 5 is disabled, the scanner only decodes Interleaved 2 of 5 barcodes with a length of 6 characters and the last character as the check character.

Security Level



@IT6SEC0

****Set Security Level 1**



@ IT6SEC1

Set Security Level 2



@ IT6SEC2

Set Security Level 3



@ IT6SEC3

Set Security Level 4

Standard 2/5

Restore Factory Defaults



@S25DEF

Restore the Factory Defaults of Standard 25

Enable/Disable Standard 2/5



@S25ENA1

Enable Standard 25



@S25ENA0

**** Disable Standard 25**



If the scanner fails to identify Standard 25 barcodes, you may first try this solution by scanning the **Enable Standard 25** barcode.

Set Length Range for Standard 25

The scanner can be configured to only decode Standard 25 barcodes with lengths that fall between (inclusive) the minimum and maximum lengths. To accomplish it, you need to set the minimum and maximum lengths.



@S25MIN

Set the Minimum Length (Default: 1)



@S25MAX

Set the Maximum Length (Default: 128)



If minimum length is set to be greater than maximum length, the scanner only decodes Standard 25 barcodes with either the minimum or maximum length. If minimum length is same as maximum length, only Standard 25 barcodes with that length are to be decoded.



Set the scanner to decode Standard 25 barcodes containing between 8 and 12 characters:

1. Scan the **Set the Minimum Length** barcode.
2. Scan the numeric barcode "8" from the "Digit Barcodes" section in Appendix.
3. Scan the **Save** barcode from the "Save/Cancel Barcodes" section in Appendix.
4. Scan the **Set the Maximum Length** barcode.
5. Scan the numeric barcodes "1" and "2" from the "Digit Barcodes" section in Appendix.
6. Scan the **Save** barcode from the "Save/Cancel Barcodes" section in Appendix.

Check Character Verification

A check character is optional for Standard 25 and can be added as the last character. It is a calculated value used to verify the integrity of the data.

- ◇ **Disable:** The scanner transmits Standard 25 barcodes as is.
- ◇ **Do Not Transmit Check Character After Verification:** The scanner checks the integrity of all Standard 25 barcodes to verify that the data complies with the check character algorithm. Barcodes passing the check will be transmitted except the last digit, whereas those failing it will not be transmitted.
- ◇ **Transmit Check Character After Verification:** The scanner checks the integrity of all Standard 25 barcodes to verify that the data complies with the check character algorithm. Barcodes passing the check will be transmitted, whereas those failing it will not be transmitted.



@S25CHK0

**** Disable**



@S25CHK1

Do Not Transmit Check Character After Verification



@S25CHK2

Transmit Check Character After Verification



If the **Do Not Transmit Check Character After Verification** option is enabled, Standard 25 barcodes with a length that is less than the configured minimum length after having the check character excluded will not be decoded. (For example, when the **Do Not Transmit Check Character After Verification** option is enabled and the minimum length is set to 4, Standard 25 barcodes with a total length of 4 characters including the check character cannot be read.)

Security Level



@S25SEC0

****Set Security Level 1**



@S25SEC1

Set Security Level 2



@S25SEC2

Set Security Level 3



@S25SEC3

Set Security Level 4

Plessey

Restore Factory Defaults



@PLYDEF

Restore the Factory Defaults of Plessey

Enable/Disable Plessey



@PLYENA1

Enable Plessey



@PLYENA0

**** Disable Plessey**



If the scanner fails to identify Plessey barcodes, you may first try this solution by scanning the **Enable Plessey** barcode.

Set Length Range for Plessey

The scanner can be configured to only decode Plessey barcodes with lengths that fall between (inclusive) the minimum and maximum lengths. To accomplish it, you need to set the minimum and maximum lengths.



@PLYMIN

Set the Minimum Length (Default: 1)



@PLYMAX

Set the Maximum Length (Default: 128)



If minimum length is set to be greater than maximum length, the scanner only decodes Plessey barcodes with either the minimum or maximum length. If minimum length is same as maximum length, only Plessey barcodes with that length are to be decoded.



Set the scanner to decode Plessey barcodes containing between 8 and 12 characters:

1. Scan the **Set the Minimum Length** barcode.
2. Scan the numeric barcode "8" from the "Digit Barcodes" section in Appendix.
3. Scan the **Save** barcode from the "Save/Cancel Barcodes" section in Appendix.
4. Scan the **Set the Maximum Length** barcode.
5. Scan the numeric barcodes "1" and "2" from the "Digit Barcodes" section in Appendix.
6. Scan the **Save** barcode from the "Save/Cancel Barcodes" section in Appendix.

Check Character Verification

Check characters are optional for Plessey and can be added as the last two characters, which are calculated values used to verify the integrity of the data.

- ✧ **Disable:** The scanner transmits Plessey barcodes as is.
- ✧ **Do Not Transmit Check Character After Verification:** The scanner checks the integrity of all Plessey barcodes to verify that the data complies with the check character algorithm. Barcodes passing the checks will be transmitted except the last two digits, whereas those failing them will not be transmitted.
- ✧ **Transmit Check Character After Verification:** The scanner checks the integrity of all Plessey barcodes to verify that the data complies with the check character algorithm. Barcodes passing the checks will be transmitted, whereas those failing them will not be transmitted.



@PLYCHK0

**** Disable**



@PLYCHK1

Do Not Transmit Check Character After Verification



@PLYCHK2

Transmit Check Character After Verification



If the **Do Not Transmit Check Character After Verification** option is enabled, Plessey barcodes with a length that is less than the configured minimum length after having the check characters excluded will not be decoded. (For example, when the **Do Not Transmit Check Character After Verification** option is enabled and the minimum length is set to 4, Plessey barcodes with a total length of 4 characters including the check characters cannot be read.)

Security Level



@PLYSEC0

****Set Security Level 1**



@PLYSEC1

Set Security Level 2



@PLYSEC2

Set Security Level 3



@PLYSEC3

Set Security Level 4

PDF417

Restore Factory Defaults



@PDFDEF

Restore the Factory Defaults of PDF417

Enable/Disable PDF417



@PDFENA1

Enable PDF417



@PDFENA0

****Disable PDF417**



If the scanner fails to identify PDF417 barcodes, you may first try this solution by scanning the **Enter Setup** barcode and then **Enable PDF417** barcode.

Set Length Range for PDF417

The scanner can be configured to only decode PDF417 barcodes with lengths that fall between (inclusive) the minimum and maximum lengths. To accomplish it, you need to set the minimum and maximum lengths.



@PDFMIN

Set the Minimum Length (Default: 1)



@PDFMAX

Set the Maximum Length (Default: 2710)



Minimum length is not allowed to be greater than maximum length. If you only want to read PDF417 barcodes with a specific length, set both minimum and maximum lengths to be that desired length.



Set the scanner to decode PDF417 barcodes containing between 8 and 12 characters:

1. Scan the **Set the Minimum Length** barcode.
2. Scan the numeric barcode “8” from the “Digit Barcodes” section in Appendix.
3. Scan the **Save** barcode from the “Save/Cancel Barcodes” section in Appendix.
4. Scan the **Set the Maximum Length** barcode.
5. Scan the numeric barcodes “1” and “2” from the “Digit Barcodes” section in Appendix.
6. Scan the **Save** barcode from the “Save/Cancel Barcodes” section in Appendix.

PDF417 Inverse

Regular barcode: Dark bars on a bright background.

Inverse barcode: Bright bars on a dark background.



@PDFINV0

Decode Regular PDF417 Barcodes Only



@PDFINV1

Decode Inverse PDF417 Barcodes Only



@PDFINV2

****Decode Both**

PDF417 ECI Output



@PDFECI0;

Disable PDF417 ECI Output



@PDFECI1;

**** Enable PDF417 ECI Output**

Character Encoding



@PDFENC0

Default Character Encoding



@PDFENC1

UTF-8



@PDFENC2;

**** Automatically Select UTF-8 or Code Page**

QR Code

Restore Factory Defaults



@QRCDEF

Restore the Factory Defaults of QR Code

Enable/Disable QR Code



@QRCENA1

** Enable QR Code



@QRCENA0

Disable QR Code



If the scanner fails to identify QR Code barcodes, you may first try this solution by scanning the **Enable QR Code** barcode.

Set Length Range for QR Code

The scanner can be configured to only decode QR Code barcodes with lengths that fall between (inclusive) the minimum and maximum lengths. To accomplish it, you need to set the minimum and maximum lengths.



@QRCMIN

Set the Minimum Length (Default: 1)



@QRMAX

Set the Maximum Length (Default: 7089)



Minimum length is not allowed to be greater than maximum length. If you only want to read QR Code barcodes with a specific length, set both minimum and maximum lengths to be that desired length.



Set the scanner to decode QR Code barcodes containing between 8 and 12 characters:

1. Scan the **Set the Minimum Length** barcode.
2. Scan the numeric barcode "8" from the "Digit Barcodes" section in Appendix.
3. Scan the **Save** barcode from the "Save/Cancel Barcodes" section in Appendix.
4. Scan the **Set the Maximum Length** barcode.
5. Scan the numeric barcodes "1" and "2" from the "Digit Barcodes" section in Appendix.
6. Scan the **Save** barcode from the "Save/Cancel Barcodes" section in Appendix.

QR Inverse

Regular barcode: Dark bars on a bright background.

Inverse barcode: Bright bars on a dark background.



@QRCINV0

Decode Regular QR Barcodes Only



@QRCINV1

**** Decode Inverse QR Barcode Only**



@QRCINV2

**** Decode Both**

Character Encoding



@QRCENC0

**** Default Character Encoding**



@QRCENC1

UTF-8



@QRCENC3

**** Automatically Select UTF-8 or Code Page**

QR ECI Output



@QRCEC10

Disable QR ECI Output



@QRCEC11

**** Enable QR ECI Output**

Website QR Code



@QRCURL1

**** Enable**



@QRCURL0

Disable

Custom URL QR

You can append to the QR barcode data several user-defined strings (separated by "|") that cannot exceed 64 characters, including separators (HEX values from 0x00 to 0xFF). When URL QR is enabled, the scanner will not read the QR code whose barcode data starts with custom strings.



@QRCURS
****Enable**

Micro QR Code

Restore Factory Defaults



@MQRDEF

**** Restore the Factory Defaults of Micro QR**

Enable/Disable Micro QR



@MQRENA1

**** Enable Micro QR**



@MQRENA0

Disable Micro QR



If the scanner fails to identify Micro QR barcodes, you may first try this solution by scanning the **Enter Setup** barcode and then **Enable Micro QR** barcode.

Set Length Range for Micro QR

The scanner can be configured to only decode Micro QR barcodes with lengths that fall between (inclusive) the minimum and maximum lengths. To accomplish it, you need to set the minimum and maximum lengths.



@MQRMIN

Set the Minimum Length (Default: 1)



@MQRMIN

Set the Maximum Length (Default: 35)



Minimum length is not allowed to be greater than maximum length. If you only want to read Micro QR barcodes with a specific length, set both minimum and maximum lengths to be that desired length.



Set the scanner to decode Micro QR Code barcodes containing between 8 and 12 characters:

1. Scan the **Enter Setup** barcode.
2. Scan the **Set the Minimum Length** barcode.
3. Scan the numeric barcode “8” from the “Digit Barcodes” section in Appendix.
4. Scan the **Save** barcode from the “Save/Cancel Barcodes” section in Appendix.
5. Scan the **Set the Maximum Length** barcode.
6. Scan the numeric barcodes “1” and “2” from the “Digit Barcodes” section in Appendix.
7. Scan the **Save** barcode from the “Save/Cancel Barcodes” section in Appendix.
8. Scan the **Exit Setup** barcode.

Data Matrix

Restore Factory Defaults



@DMCDEF

Restore the Factory Defaults of Data Matrix

Enable/Disable Data Matrix



@DMCENA1

**** Enable Data Matrix**



@DMCENA0

Disable Data Matrix

Set Length Range for Data Matrix

The scanner can be configured to only decode Data Matrix barcodes with lengths that fall between (inclusive) the minimum and maximum lengths. To accomplish it, you need to set the minimum and maximum lengths.



@DMCMIN

Set the Minimum Length (Default: 1)



@DMCMAX

Set the Maximum Length (Default: 3116)



Minimum length is not allowed to be greater than maximum length. If you only want to read Data Matrix barcodes with a specific length, set both minimum and maximum lengths to be that desired length.

E *example*

Set the scanner to decode Data Matrix barcodes containing between 8 and 12 characters:

1. Scan the **Set the Minimum Length** barcode.
2. Scan the numeric barcode "8" from the "Digit Barcodes" section in Appendix.
3. Scan the **Save** barcode from the "Save/Cancel Barcodes" section in Appendix.
4. Scan the **Set the Maximum Length** barcode.
5. Scan the numeric barcodes "1" and "2" from the "Digit Barcodes" section in Appendix.
6. Scan the **Save** barcode from the "Save/Cancel Barcodes" section in Appendix.

Rectangular Barcode

Data Matrix has two formats:

Square barcodes having the same amount of modules in length and width: 10*10, 12*12.... 144*144.

Rectangular barcodes having different amounts of models in length and width: 6*16, 6*14...14*22.



@DMCREC1

**** Enable Rectangular Barcode**



@DMCREC0

Disable Rectangular Barcode

Data Matrix Inverse

Regular barcode: Dark bars on a bright background.

Inverse barcode: Bright bars on a dark background.



@DMCINV0

Decode Regular Data Matrix Barcodes Only



@DMCINV1

**** Decode Inverse Data Matrix Barcode Only**



@DMCINV2

**** Decode Both**

Character Encoding



@DMCENC0

Default Character Encoding



@DMCENC1

UTF-8



@DMCENC2

**** Automatically Select UTF-8 or Code Page**

Data Matrix ECI Output



@DMCEC10

Disable Data Matrix ECI Output



@DMCEC11

**** Enable Data Matrix ECI Output**

Aztec

Restore Factory Defaults



@AZTDEF

****Restore the Factory Defaults of Aztec Code**

Enable/Disable Aztec Code



@AZTENA1

Enable Aztec Code



@AZTENA0

****Disable Aztec Code**



If the scanner fails to identify Aztec Code barcodes, you may first try this solution by scanning the **Enter Setup** barcode and then **Enable Aztec Code** barcode.

Set Length Range for Aztec Code

The scanner can be configured to only decode Aztec barcodes with lengths that fall between (inclusive) the minimum and maximum lengths. To accomplish it, you need to set the minimum and maximum lengths.



@AZTMIN

Set the Minimum Length (Default: 1)



@AZTMAX

Set the Maximum Length (Default: 3832)



Minimum length is not allowed to be greater than maximum length. If you only want to read Aztec barcodes with a specific length, set both minimum and maximum lengths to be that desired length.



Set the scanner to decode Aztec barcodes containing between 8 and 12 characters:

1. Scan the **Enter Setup** barcode.
2. Scan the **Set the Minimum Length** barcode.
3. Scan the numeric barcode “8” from the “Digit Barcodes” section in Appendix.
4. Scan the **Save** barcode from the “Save/Cancel Barcodes” section in Appendix.
5. Scan the **Set the Maximum Length** barcode.
6. Scan the numeric barcodes “1” and “2” from the “Digit Barcodes” section in Appendix.
7. Scan the **Save** barcode from the “Save/Cancel Barcodes” section in Appendix.
8. Scan the **Exit Setup** barcode.

Aztec Inverse

Regular barcode: Dark bars on a bright background.

Inverse barcode: Bright bars on a dark background.



@AZTINV0

Decode Regular Aztec Barcodes Only



@AZTINV1

Decode Inverse Aztec Barcode Only



@AZTINV2

**** Decode Both**

Character Encoding



@AZTENC0

Default Character Encoding



@AZTENC1

UTF-8



@AZTENC2

Automatically Select UTF-8 or Code Page

Aztec ECI Output



@AZTECI0

Disable Aztec ECI Output



@AZTECI1

Enable Aztec ECI Output

Chapter 8 Prefix & Suffix

Introduction

A 1D barcode could contain digits, letters, symbols, etc. A 2D barcode could contain more data, such as Chinese characters and other multi-byte characters. However, in real applications, they do not and should not have all information we need, such as barcode type, data acquisition time and delimiter, in order to keep the barcodes short and flexible.

Prefix and suffix are how to fulfill the needs mentioned above. They can be added, removed and modified while the original barcode data remains intact.



Barcode processing procedure:

1. Edit data with Data Formatter
2. Append prefix/suffix
3. Pack data
4. Append terminating character

Global Settings

Enable/Disable All Prefixes/Suffixes

Disable All Prefixes/Suffixes: Transmit barcode data with no prefix/suffix.

Enable All Prefixes/Suffixes: Allow to append Code ID prefix, AIM ID prefix, custom prefix/suffix and terminating character to the barcode data before the transmission.



@APSENA0

Disable All Prefixes/Suffixes



@APSENA1

Enable All Prefixes/Suffixes

Prefix Sequence



@PRESEQ0

**** Code ID+ Custom +AIM ID**



@PRESEQ1

Custom + Code ID + AIM ID

Custom Prefix

Enable/Disable Custom Prefix

If custom prefix is enabled, you are allowed to append to the data a user-defined prefix that cannot exceed 10 characters. For example, if the custom prefix is “AB” and the barcode data is “123”, the Host will receive “AB123”.



@CPRENA0

**** Disable Custom Prefix**



@CPRENA1

Enable Custom Prefix

Set Custom Prefix

To set a custom prefix, scan the **Set Custom Prefix** barcode then the numeric barcodes corresponding to the hexadecimal value of a desired prefix then the **Save** barcode.

Note: A custom prefix cannot exceed 10 characters.



@CPRSET

Set Custom Prefix

E
xample

Set the custom prefix to “CODE” (HEX: 0x43/0x4F/0x44/0x45):

1. Scan the **Set Custom Prefix** barcode.
2. Scan the numeric barcodes “4”, “3”, “4”, “F”, “4”, “4”, “4” and “5” from the “Digit Barcodes” section in Appendix.
3. Scan the **Save** barcode from the “Save/Cancel Barcodes” section in Appendix.
4. Scan the **Enable Custom Prefix** barcode.

AIM ID Prefix

AIM (Automatic Identification Manufacturers) ID defines symbology identifier (For the details, see the “AIM ID Table” section in Appendix). If AIM ID prefix is enabled, the scanner will add the symbology identifier before the scanned data after decoding.



@AIDENA0

**** Disable AIM ID Prefix**



@AIDENA1

Enable AIM ID Prefix



AIM ID is not user programmable.

Code ID Prefix

Code ID can also be used to identify barcode type. Unlike AIM ID, Code ID is user programmable. Code ID can only consist of one or two English letters.



@CIDENA0

**** Disable Code ID Prefix**



@CIDENA1

Enable Code ID Prefix

Restore All Default Code IDs

For the information of default Code IDs, see the "Code ID Table" section in Appendix.



@CIDDEF

Restore All Default Code IDs

Modify Code ID

See the examples below to learn how to modify a Code ID and restore the default Code IDs of all symbologies.

E
xample

Modify PDF417 Code ID to be “p” (HEX: 0x70):

1. Scan the **Modify PDF417 Code ID** barcode.
2. Scan the numeric barcodes “7” and “0” from the “Digit Barcodes” section in Appendix.
3. Scan the **Save** barcode from the “Save/Cancel Barcodes” section in Appendix.

Restore the default Code IDs of all symbologies:

1. Scan the **Restore All Default Code IDs** barcode. **1D symbologies:**



@CID002

Modify Code 128 Code ID



@CID003

Modify GS1-128 Code ID



@CID004

Modify EAN-8 Code ID



@CID005

Modify EAN-13 Code ID



@CID006

Modify UPC-E Code ID



@CID007

Modify UPC-A Code ID



@CID008

Modify Interleaved 2 of 5 Code ID



@CID009

Modify ITF-14 Code ID



@CID010

Modify ITF-6 Code ID



@CID011

Modify Matrix 2 of 5 Code ID



@CID013

Modify Code 39 Code ID



@CID015

Modify Codabar Code ID



@CID017

Modify Code 93 Code ID



@CID020

Modify AIM 128 Code ID



@CID021

Modify ISBT 128 Code ID



@CID023

Modify ISSN Code ID



@CID025

Modify Industrial 25 Code ID



@CID026

Modify Standard 25 Code ID



@CID027

Modify Plessey Code ID



@CID028

Modify Code 11 Code ID

2D symbologies:



@CID032

Modify PDF417 Code ID



@CID033

Modify QR Code ID



@CID034

Modify Aztec Code ID



@CID035

Modify Data Matrix Code ID



@CID043

Modify Micro QR Code ID

Custom Suffix

Enable/Disable Custom Suffix

If custom suffix is enabled, you are allowed to append to the data a user-defined suffix that cannot exceed 10 characters. For example, if the custom suffix is “AB” and the barcode data is “123”, the Host will receive “123AB”.



@CSUENA0

**** Disable Custom Suffix**



@CSUENA1

Enable Custom Suffix

Set Custom Suffix

To set a custom suffix, scan the **Set Custom Suffix** barcode then the numeric barcodes corresponding to the hexadecimal value of a desired suffix then the **Save** barcode.

Note: A custom suffix cannot exceed 10 characters.



@CSUSET

Set Custom Suffix

E
sample

Set the custom suffix to “CODE” (HEX: 0x43/0x4F/0x44/0x45):

1. Scan the **Set Custom Suffix** barcode.
2. Scan the numeric barcodes “4”, “3”, “4”, “F”, “4”, “4”, “4” and “5” from the “Digit Barcodes” section in Appendix.
3. Scan the **Save** barcode from the “Save/Cancel Barcodes” section in Appendix.
4. Scan the **Enable Custom Suffix** barcode.

Terminating Character Suffix

Enable/Disable Terminating Character Suffix

A terminating character such as carriage return (CR) or carriage return/line feed pair (CRLF) can only be used to mark the end of data, which means nothing can be added after it.



@TSUENA0

Disable Terminating Character Suffix



@TSUENA1

**** Enable Terminating Character Suffix**

Set Terminating Character Suffix

To set a terminating character suffix, scan the **Set Terminating Character Suffix** barcode then the numeric barcodes corresponding to the hexadecimal value of a desired terminating character then the **Save** barcode.

Note: A terminating character suffix cannot exceed 2 characters.



@TSUSET

Set Terminating Character Suffix



@TSUSET0D

** Set Terminating Character to CR (0x0D)



@TSUSET0D0A

Set Terminating Character to CRLF (0x0D,0x0A)

Set the terminating character suffix to 0x0A:

1. Scan the **Set Terminating Character Suffix** barcode.
2. Scan the numeric barcodes “0” and “A” from the “Digit Barcodes” section in Appendix.
3. Scan the **Save** barcode from the “Save/Cancel Barcodes” section in Appendix.
4. Scan the **Enable Terminating Character Suffix** barcode.

Chapter 9 Data Formatter

Introduction

You may use the Data Formatter to modify the scanner's output. For example, you can use the Data Formatter to insert characters at certain points in barcode data or to suppress/replace/send certain characters in barcode data as it is scanned.

Normally, when you scan a barcode, it gets outputted automatically; however, when you create a format, you must use a "send" command (see the "Send Commands" section in this chapter) within the format programming to output data. Multiple data formats can be programmed into the scanner. The maximum size of all data formats created is 2048 characters. By default, the data formatter is disabled. Enable it when required. If you have changed data format settings, and wish to clear all formats and return to the factory defaults, scan the **Default Data Format** code below.



@DFMDEF

Default Data Format

Add a Data Format

Data format is used to edit barcode data. When you create a data format, you must select one of the four labels (Format_0, Format_1, Format_2 and Format_3) for your data format, specify the application scope of data format (such as barcode type and data length) and include formatter commands. Multiple data formats may be created using the same label. When scanned data does not match your data format requirements, you will hear the non-match error beep (if the non-match error beep is ON).

There are two methods to program a data format: Programming with barcodes and programming with serial commands.

Programming with Barcodes

The following explains how to program a data format by scanning the specific barcodes. Scanning any irrelevant barcode or failing to follow the setting procedure will result in programming failure. To find the alphanumeric barcodes needed to create a data format, see the "Digit Barcodes" section in Appendix.

Step 1: Scan the **Add Data Format** barcode.



@DFMADD

Add Data Format

Step 2: Select a label (Format_0 or Format_1 or Format_2 or Format_3).

Scan a numeric barcode **0** or **1** or **2** or **3** to label this data format Format_0 or Format_1 or Format_2 or Format_3.

Step 3: Select formatter command type.

Specify what type of formatter commands will be used. Scan a numeric barcode “6” to select formatter command type 6. (See the “Formatter Command Type 6” section in this chapter for more information)

Step 4: Set interface type

Scan **999** for any interface type.

Step 5: Set Symbology ID Number

Refer to the “Symbology ID Number” section in Appendix and find the ID number of the symbology to which you want to apply the data format. Scan three numeric barcodes for the symbology ID number. If you wish to create a data format for all symbologies, scan **999**.

Step 8: Set barcode data length

Specify what length of data will be acceptable for this symbology. Scan the four numeric barcodes that represent the data length. 9999 is a universal number, indicating all lengths. For example, 32 characters should be entered as 0032.

Step 9: Enter formatter command

Refer to the “Formatter Command Type 6” section in this chapter. Scan the alphanumeric barcodes that represent the command you need to edit data. For example, when a command is F141, you should scan F141.

Step 10: Scan the **Save** barcode from the “Save/Cancel Barcodes” section in Appendix to save your data format.

Example: Program a Format_0 data format using formatter command type 6, Code 128 containing 10 characters applicable, send all characters followed by “A”.

- | | |
|---|---|
| 1. Scan the Add Data Format barcode | Add a data format |
| 2. Scan the 0 barcode | Select Format_0 as the label |
| 3. Scan the 6 barcode | Select formatter command type 6 |
| 4. Scan the 9 barcode three times | All interface types applicable |
| 5. Scan the barcodes 002 | Only Code 128 applicable |
| 6. Scan the barcodes 0010 | Only a length of 10 characters applicable |
| 7. Scan the alphanumeric barcodes F141 | Send all characters followed by “A” (HEX: 41) |
| 8. Scan the Save barcode | Save the data format |

To streamline the programming process, you may as well generate a batch barcode by inputting the command (e.g. **@DFMADD069990020010F141;**) used to create a data format. See the “Use Batch Barcode” section in Chapter 10 to learn how to put a batch barcode into use.

When creating multiple data formats sharing a label, the formats are separated from each other by a vertical bar (|) in the batch command, e.g. **@DFMADD069990029999F141|069990039999F142|069990049999F143;**.

Programming with Serial Commands

A data format can also be created by serial commands (HEX) sent from the host device. **All commands must be entered in uppercase letters.**

The syntax consists of the following elements:

Prefix: "~<SOH>0000" (HEX: **7E 01 30 30 30 30**), 6 characters.

Storage type: "@" (HEX: **40**) or "#" (HEX: **23**), 1 character. "@" means permanent setting which will not be lost by removing power from the scanner or rebooting it; "#" means temporary setting which will be lost by removing power from the scanner or rebooting it.

Add Data Format Command: "DFMADD" (HEX: **44 46 4D 41 44 44**), 6 characters.

Data format label: "0" (HEX: **30**) or "1" (HEX: **31**) or "2" (HEX: **32**) or "3" (HEX: **33**), 1 character. "0", "1", "2" and "3" represent Format_0, Format_1, Format_2 and Format_3 respectively.

Formatter command type: "6" (HEX: **36**), 1 character.

Interface type: "999" (HEX: **39 39 39**), 3 characters.

Symbology ID Number: The ID number of the symbology to which you want to apply the data format, 3 characters. 999 indicates all symbologies.

Data length: The length of data that will be acceptable for this symbology, 4 characters. 9999 indicates all lengths. For example, 32 characters should be entered as 0032.

Formatter commands: The command string used to edit data. For more information, see the "Formatter Command Type 6" section in this chapter.

Suffix: ";<ETX>" (HEX: **3B 03**), 2 characters.

Example: Program a Format_0 data format using formatter command type 6, Code 128 containing 10 characters applicable, send all characters followed by "A".

Enter: **7E 01 30 30 30 30 40 44 46 4D 41 44 44 30 36 39 39 39 30 30 33 39 39 39 39 46 31 34 31 3B 03**
(~<SOH>0000@DFMADD069990020010F141;<ETX>)

Response: **02 01 30 30 30 30 40 44 46 4D 41 44 44 30 36 39 39 39 30 30 33 39 39 39 39 46 31 34 31 06 3B 03**
(<STX><SOH>0000@DFMADD069990020010F141<ACK>;<ETX>)

When creating multiple data formats sharing a label, the formats are separated from each other by a vertical bar (|) in the serial command.

Example: ~<SOH>0000@DFMADD069990020010F141|069990039999F142|069990049999F143;<ETX>

Enable/Disable Data Formatter

When Data Formatter is disabled, the barcode data is outputted to the host as read, including prefixes and suffixes.



@DFMENA0

**** Disable Data Formatter**

You may wish to require the data to conform to a data format you have created. The following settings can be applied to your data format:

Enable Data Formatter, Required, Keep Prefix/Suffix: Scanned data that meets your data format requirements is modified accordingly and gets outputted along with prefixes and suffixes (if prefix and suffix are enabled). Any data that does not match your data format requirements generates an error beep (if Non-Match Error Beep is turned ON) and the data in that barcode is not transmitted.

Enable Data Formatter, Required, Drop Prefix/Suffix: Scanned data that meets your data format requirements is modified accordingly and gets outputted without prefixes and suffixes (even if prefix and suffix are enabled). Any data that does not match your data format requirements generates an error beep (if Non-Match Error Beep is turned ON) and the data in that barcode is not transmitted.

Enable Data Formatter, Not Required, Keep Prefix/Suffix: Scanned data that meets your data format requirements is modified accordingly and gets outputted along with prefixes and suffixes (if prefix and suffix are enabled). Barcode data that does not match your data format requirements is transmitted as read along with prefixes and suffixes (if prefix and suffix are enabled).

Enable Data Formatter, Not Required, Drop Prefix/Suffix: Scanned data that meets your data format requirements is modified accordingly and gets outputted without prefixes and suffixes (even if prefix and suffix are enabled). Barcode data that does not match your data format requirements is transmitted as read along with prefixes and suffixes (if prefix and suffix are enabled).



@DFMENA1

Enable Data Formatter, Required, Keep Prefix/Suffix



@DFMENA2

Enable Data Formatter, Required, Drop Prefix/Suffix



@DFMENA3

Enable Data Formatter, Not Required, Keep Prefix/Suffix



@DFMENA4

Enable Data Formatter, Not Required, Drop Prefix/Suffix

Non-Match Error Beep

If Non-Match Error Beep is turned ON, the scanner generates an error beep when a barcode is encountered that does not match your required data format.



@DFMTON0

Non-Match Error Beep Off



@DFMTON1

**** Non-Match Error Beep On**

Data Format Selection

After enabling the Data Formatter, you can select a data format you want to use by scanning the appropriate barcode below.



@DFMUSE0
**** Format_0**



@DFMUSE2
Format_2



@DFMUSE1
Format_1



@DFMUSE3
Format_3

Change Data Format for a Single Scan

You can switch between data formats for a single scan. The next barcode is scanned using the data format selected here, then reverts to the format you have selected above. For example, you may have set your scanner to the data format you saved as Format_3. You can switch to Format_1 for a single trigger pull by scanning the **Single Scan – Format_1** barcode below. The next barcode that is scanned uses Format_1, then reverts back to Format_3.

Note: This setting will be lost by removing power from the scanner, or turning off/ rebooting the device.



@DFMSIN0

Single Scan – Format_0



@DFMSIN1

Single Scan – Format_1



@DFMSIN2

Single Scan – Format_2



@DFMSIN3

Single Scan – Format_3

Clear Data Format

There are two methods to remove data format created from your scanner:

Delete one data format: Scan the **Clear One** barcode, a numeric barcode (0-3) and the **Save** barcode. For example, to delete Format_2, you should scan the **Clear One** barcode, the **2** barcode and the **Save** barcode

Delete all data formats: Scan the **Clear All** barcode.



@DFMCAL

Clear All



@DFMCLR

Clear One

Query Data Formats

You may scan the appropriate barcode below to get the information of data format(s) created by you or preset by manufacturer. For instance, if you have added Format_0 as per the example in the “Add a Data Format” section in this chapter, scanning the **Query Current Data Formats** barcode, you will get the result: **Data Format0:069990020010F141;**



@DFMQCU

Query Current Data Formats



@DFMQFA

Query Preset Data Formats

Formatter Command

When working with the Data Formatter, a virtual cursor is moved along your input data string. The following commands are used to both move this cursor to different positions, and to select, replace, and insert data into the final output. For the hex value of ASCII characters involved in the commands, refer to the “ASCII Table” in Appendix.

Send Commands

F1 Send all characters

Syntax=F1xx (xx: The insert character’s hex value)

Include in the output message all of the characters from the input message, starting from current cursor position, followed by an insert character.

F2 Send a number of characters

Syntax=F2nnxx (nn: The numeric value (00-99) for the number of characters; xx: The insert character’s hex value)

Include in the output message a number of characters followed by an insert character. Start from the current cursor position and continue for “nn” characters or through the last character in the input message, followed by character “xx.”

F2 Example: Send a number of characters



Send the first 10 characters from the barcode above, followed by a carriage return.

Command string: **F2100D**

F2 is the “Send a number of characters” command

10 is the number of characters to send

0D is the hex value for a CR

The data is output as: **1234567890**

<CR>

F3 Send all characters up to a particular character

Syntax=F3ssxx (ss: The particular character's hex value; xx: The insert character's hex value)

Include in the output message all characters from the input message, starting with the character at the current cursor position and continuing to, but not including, the particular character "ss," followed by character "xx." The cursor is moved forward to the "ss" character.

F3 Example: Send all characters up to a particular character



Using the barcode above, send all characters up to but not including "D," followed by a carriage return.

Command string: **F3440D**

F3 is the "Send all characters up to a particular character" command

44 is the hex value for a "D"

0D is the hex value for a CR

The data is output as: **1234567890ABC**

<CR>

E9 Send all but the last characters

Syntax=E9nn (nn: The numeric value (00-99) for the number of characters that will not be sent at the end of the message)

Include in the output message all but the last "nn" characters, starting from the current cursor position. The cursor is moved forward to one position past the last input message character included.

F4 Insert a character multiple times

Syntax=F4xxnn (xx: The insert character's hex value; nn: The numeric value (00-99) for the number of times it should be sent)

Send "xx" character "nn" times in the output message, leaving the cursor in the current position.

E9 and F4 Example: Send all but the last characters, followed by 2 tabs



Send all characters except for the last 8 from the barcode above, followed by 2 tabs.

Command string: **E908F40902**

E9 is the "Send all but the last characters" command

08 is the number of characters at the end to ignore

F4 is the "Insert a character multiple times" command

09 is the hex value for a horizontal tab

02 is the number of time the tab character is sent

The data is output as: **1234567890AB<tab><tab>**

B3 Insert symbology name

Insert the name of the barcode's symbology in the output message, without moving the cursor.

B4 Insert barcode length

Insert the barcode's length in the output message, without moving the cursor. The length is expressed as a numeric string and does not include leading zeros.

B3 and B4 Example: Insert the symbology name and length



Send the symbology name and length before the barcode data from the barcode above. Break up these insertions with spaces. End with a carriage return.

Command string: **B3F42001B4F42001F10D**

B3 is the "Insert symbology name" command

F4 is the "Insert a character multiple times" command

20 is the hex value for a space

01 is the number of time the space character is sent

B4 is the "Insert barcode length" command

F4 is the "Insert a character multiple times" command

20 is the hex value for a space

01 is the number of time the space character is sent

F1 is the "Send all characters" command

0D is the hex value for a CR

The data is output as: **Code128 20 1234567890ABCDEFGHIJ**

<CR>

Move Commands

F5 Move the cursor forward a number of characters

Syntax=F5nn (nn: The numeric value (00-99) for the number of characters the cursor should be moved ahead)

Move the cursor ahead "nn" characters from current cursor position.

F5 Example: Move the cursor forward and send the data



Move the cursor forward 3 characters, then send the rest of the barcode data from the barcode above. End with a carriage return.

Command string: **F503F10D**

F5 is the "Move the cursor forward a number of characters" command

03 is the number of characters to move the cursor

F1 is the "Send all characters" command

0D is the hex value for a CR

The data is output as: **4567890ABCDEFGHIJ**

<CR>

F6 Move the cursor backward a number of characters

Syntax=F6nn (nn: The numeric value (00-99) for the number of characters the cursor should be moved back)

Move the cursor back "nn" characters from current cursor position.

F7 Move the cursor to the beginning

Syntax=F7

Move the cursor to the first character in the input message.

EA Move the cursor to the end

Syntax=EA

Move the cursor to the last character in the input message.

Search Commands

F8 Search forward for a character

Syntax=F8xx (xx: The search character's hex value)

Search the input message forward for "xx" character from the current cursor position, leaving the cursor pointing to the "xx" character.

F8 Example: Send barcode data that starts after a particular character



Search for the letter "D" in barcodes and send all the data that follows, including the "D". Using the barcode above:

Command string: **F844F10D**

F8 is the "Search forward for a character" command

44 is the hex value for "D"

F1 is the "Send all characters" command

0D is the hex value for a CR

The data is output as: **DEFGHIJ**

<CR>

F9 Search backward for a character

Syntax=F9xx(xx: The search character's hex value)

Search the input message backward for "xx" character from the current cursor position, leaving the cursor pointing to the "xx" character.

B0 Search forward for a string

Syntax=B0nnnnS (nnnn: The string length (up to 9999); S: The ASCII hex value of each character in the string)

Search forward for “S” string from the current cursor position, leaving cursor pointing to “S” string. For example, B0000454657374 will search forward for the first occurrence of the 4-character string “Test.”

B0 Example: Send barcode data that starts after a string of characters



Search for the letters “FGH” in barcodes and send all the data that follows, including “FGH.” Using the barcode above:

Command string: **B00003464748F10D**

B0 is the “Search forward for a string” command

0003 is the string length (3 characters)

46 is the hex value for “F”

47 is the hex value for “G”

48 is the hex value for “H”

F1 is the “Send all characters” command

0D is the hex value for a CR

The data is output as: **FGHIJ**

<CR>

B1 Search backward for a string

Syntax=B1nnnnS (nnnn: The string length (up to 9999); S: The ASCII hex value of each character in the string)

Search backward for “S” string from the current cursor position, leaving cursor pointing to “S” string. For example, B1000454657374 will search backward for the first occurrence of the 4-character string “Test.”

E6 Search forward for a non-matching character

Syntax=E6xx (xx: The search character's hex value)

Search the input message forward for the first non-"xx" character from the current cursor position, leaving the cursor pointing to the non-"xx" character.

E6 Example: Remove zeros at the beginning of barcode data



This example shows a barcode that has been zero filled. You may want to ignore the zeros and send all the data that follows. E6 searches forward for the first character that is not zero, then sends all the data after, followed by a carriage return. Using the barcode above:

Command string: **E630F10D**

E6 is the "Search forward for a non-matching character" command

30 is the hex value for 0

F1 is the "Send all characters" command

0D is the hex value for a CR

The data is output as: **123abc**

<CR>

E7 Search backward for a non-matching character

Syntax=E7xx(xx: The search character's hex value)

Search the input message backward for the first non-"xx" character from the current cursor position, leaving the cursor pointing to the non-"xx" character.

Miscellaneous Commands

FB Suppress characters

Syntax=FBnnxyy..zz (nn: The numeric value (00-15) for the number of suppressed characters; xyy..zz: The hex value of the characters to be suppressed)

Suppress all occurrences of up to 15 different characters, starting at the current cursor position, as the cursor is advanced by other commands.

FB Example: Remove spaces in barcode data



12 34_5*6 78

This example shows a barcode that has spaces in the data. You may want to remove the spaces before sending the data. Using the barcode above:

Command string: **FB0120F10D**

FB is the “Suppress characters” command

01 is the number of the characters to be suppressed

20 is the hex value for a space

F1 is the “Send all characters” command

0D is the hex value for a CR

The data is output as: **1234_5*678**

<CR>

E4 Replace characters

Syntax = E4nnxx₁xx₂yy₁yy₂...zz₁zz₂(nn: The total count of the number of characters (characters to be replaced plus replacement characters; xx₁: The characters to be replaced, xx₂: The replacement characters, continuing through zz₁ and zz₂)

Replace up to 15 characters in the output message, without moving the cursor.

E4 Example: Replace zeros with CRs in barcode data



If the barcode has characters that the host application does not want included, you can use the E4 command to replace those characters with something else. In this example, you will replace the zeros in the barcode above with carriage returns.

Command string: **E402300DF10D**

E4 is the "Replace characters" command

02 is the total count of characters to be replaced, plus the replacement characters (0 is replaced by CR, so total characters=2)

30 is the hex value for 0

0D is the hex value for a CR (the character that will replace the 0)

F1 is the "Send all characters" command

0D is the hex value for a CR

The data is output as: **123**

456

78

AB

<CR>

BA Replace a string with another

Syntax = BAnnNN₁SS₁NN₂SS₂

nn: The count of replacements to be made, if nn=00 or nn>=the number of occurrences of a string to be replaced, then replace all occurrences of that string.

NN₁: The length of the string to be replaced, NN₁>0.

SS₁: The ASCII hex value of each character in the string to be replaced.

NN₂: The length of replacement string, NN₂>=0. To replace string "SS₁" with NUL (i.e. delete string "SS₁"), you should set NN₂ to 00 and leave out SS₂.

SS₂: The ASCII hex value of each character in the replacement string.

From the current cursor position, search forward for the occurrence of "SS₁" string (of length "NN₁") and replace the string with "SS₂" string (of length "NN₂") in the output message until every "SS₁" string is replaced or the count of replacements made reaches "nn" times, without moving the cursor.

BA Example: Replace "23"s with "ABC"s in barcode data



If the barcode has a string of characters that the host application does not want included, you can use the BA command to replace the string with something else. In this example, you will replace the "23"s in the barcode above with "ABC"s.

Command string: **BA0002323303414243F100**

BA is the "Replace a string with another" command

00 is the count of replacements to be made, 00 means to replace all occurrences of that string

02 is the length of the string to be replaced

32 is the hex value for 2 (character in the string to be replaced)

33 is the hex value for 3 (character in the string to be replaced)

03 is the length of the replacement string

41 is the hex value for A (character in the replacement string)

42 is the hex value for B (character in the replacement string)

43 is the hex value for C (character in the replacement string)

F1 is the "Send all characters" command

00 is the hex value for a NUL

The data is output as: **1ABC4AbcABCR01ABCU**

BA Example: Remove only the first occurrence of "23"s in barcode data

If the barcode has a string of characters that the host application wants removed, you can use the BA command to replace the string with NUL. In this example, you will remove the first occurrence of "23" in the barcode above.

Command string: **BA0102323300F100**

BA is the "Replace a string with another" command

01 is the count of replacements to be made

02 is the length of the string to be replaced

32 is the hex value for 2 (character in the string to be replaced)

33 is the hex value for 3 (character in the string to be replaced)

00 is the length of the replacement string, 00 means to replace the string to be replaced with NUL

F1 is the "Send all characters" command

00 is the hex value for a NUL

The data is output as: **14Abc23R0123U**

EF Insert a delay

Syntax=EFnnnn (nnnn: The delay in 5ms increments, up to 9999)

Inserts a delay of up to 49,995 milliseconds (in multiples of 5), starting from the current cursor position. This command can only be used with USB HID Keyboard.

EF Example: Insert a delay of 1s between the 5th and 6th character

Send the first 5 characters in a barcode, wait for 1s, then send the rest of the barcode data.

Command string: **F20500EF0200E900**

F2 is the “Send a number of characters” command

05 is the number of characters to send

00 is the hex value for a Null character

EF is the “Insert a delay” command

0200 is the delay value (5msX200=1000ms=1s)

E9 is the “Send all but the last characters” command

00 is the number of characters that will not be sent at the end of the message

Batch programming enables users to integrate a batch of commands into a single batch barcode.

Listed below are batch programming rules:

1. Command format: Command + Parameter Value.
2. Each command is terminated by a semicolon (;). Note that there is no space between a command and its terminator semicolon.
3. Use the barcode generator software to generate a 2D batch barcode.

Example: Create a batch barcode for **IlluMination On, Sense Mode, Decode Session Timeout = 2s**:

1. Input the commands:

@ILLSCN1;SCNMOD2;ORTSET2000;

2. Generate a batch barcode.

When setting up a scanner with the above configuration, scan the **Enable Batch Barcode** barcode and then the batch barcode generated.



@BATCHS

Enable Batch Barcode

Chapter 10 Lua Scripting

Introduction

Lua is a lightweight, embedded scripting language that enables customization of application functionality and controls scanner behavior.

Before starting, ensure a basic understanding of Lua programming, including variable declarations, data types, control structures (such as loops and conditionals), and function definitions. Beginners can refer to relevant Lua programming tutorials or documentation.

Enable Lua Scripting



@LUAENA1

Enable Lua Scripting

Disable Lua Scripting



@LUAENA0

Disable Lua Scripting

Reference Documentation

Lua Official Documentation: Learn detailed information about the Lua language, including syntax, data types, function libraries, and more.

Scanner API Documentation: Refer to the scanner's API documentation to understand how to call its API functions.

Appendix

Digit Barcodes

0~9



@DIGIT0

0



@DIGIT1

1



@DIGIT2

2



@DIGIT3

3



@DIGIT4

4



@DIGIT6

6



@DIGIT8

8



@DIGIT5

5



@DIGIT7

7



@DIGIT9

9

A~F



@DIGITA

A



@DIGITB

B



@DIGITC

C



@DIGITD

D



@DIGITE

E



@DIGITF

F

Save/Cancel Barcodes

After reading numeric barcode(s), you need to scan the **Save** barcode to save the data. If you scan the wrong digit(s), you can either scan the **Cancel** barcode and then start the configuration all over again, or scan the **Delete the Last Digit** barcode and then the correct digit, or scan the **Delete All Digits** barcode and then the digits you want.

For instance, after reading the **Maximum Length** barcode and numeric barcodes “1”, “2” and “3”, you scan:

- ✧ **Delete the Last Digit:** The last digit “3” will be removed.
- ✧ **Delete All Digits:** All digits “123” will be removed.
- ✧ **Cancel:** The maximum length configuration will be cancelled. And the scanner is still in the setup mode.



@DIGSAV

Save



@DIGCAN

Cancel



@DIGDEL

Delete the Last Digit



@DIGDAL

Delete All Digits

Factory Defaults Table

Parameter	Factory Default	Remark
System Settings		
Programming Barcode Data	Do not transmit	
Illumination	On	
Aiming	Normal	
Illumination Color	Red LED +White LED+ Blue LED	
Interval Time of Illumination switching	5000ms	
Good Read Vibration	Off	
Good Read Vibration Duration	100ms	
Good Read LED	On	
Good Read LED Duration	Short (20ms)	
Power On Beep	On	
Good Read Beep	On	
Good Read Beep Duration	Medium (80ms)	
Good Read Beep Frequency	Medium (2730Hz)	
Good Read Beep Volume	High	
Default Scan Mode	Level Mode	
Decode Session Timeout	3,000ms	1-3,600,000ms; 0: infinite.
Reread Timeout	Disabled, 1500ms	1-3,600,000ms
Reread Timeout Reset	Disabled	
Reread - Ignore Symbology Type	Disabled	
Good Read Delay	Disabled, 500ms	1-3,600,000ms
Image Decoding Timeout	100ms	1-3,000ms
Sensitivity	Enhanced	
After A Good Read (Sense Mode)	Go into Sensing Status	
Image Stabilization Timeout (Sense Mode)	200ms	
Scanning Preference	Normal Mode	
Read Barcode	On	
Image Flipping	Do Not Flip	
Exposure parameter Limit	Disabled	
Gain Parameter Limit	Disabled	
Image Luminance Limit	Disabled	
Default Interface	USB KBW	
Decode Central Area	Priori On Aimed Barcode	

Transmit Not Good Read Message	Disabled	
Edit NGR Message	NG	
Smart Stand Mode	Enabled	
Scan Mode After The Scanner Is Placed In The Smart Stand	Sense Mode	
RS-232 Interface		
Baud Rate	9600	
Parity Check	None	
Data Bits	8	
Stop Bits	1	
Hardware Auto Flow Control	Disabled	
USB Interface		
USB Country Keyboard	US keyboard	USB HID Keyboard
Beep on Unknown Character	Off	USB HID Keyboard
Emulate ALT+Keypad	Off	USB HID Keyboard
Code Page	Code Page 1252 (West European Latin)	USB HID Keyboard
Unicode Encoding	Off	USB HID Keyboard
Control Characters Output	Disabled	USB HID Keyboard
Inter-Keystroke Delay	No Delay	USB HID Keyboard
Caps Lock	Disabled	USB HID Keyboard
Convert Case	No Case Conversion	USB HID Keyboard
Emulate Numeric Keypad		
Numeric Character Use Numeric Keypad	Disabled	USB HID Keyboard
'+', '-', '*', '/' Use Numeric Keypad	Disabled	USB HID Keyboard
Polling Rate	4ms	USB HID Keyboard
Fast Mode	Off	
Leading Zero	On	
USB CDC Serial Port Baud Rate	High-speed mode	
Ethernet Communication		
DHCP	Off	
IP Address	192.168.1.100	
Subnet mask	255.255.255.0	
Gateway	192.168.1.1	
Remote IP	192.168.1.200	
Remote Port	10000	
Symbologies		

Global Settings		
Parentheses Surround GS1 Application Identifiers	Enabled	
1D Inverse	Regular and Inverse	
Code 128		
Code 128	Enabled	
Security Level	1	
Maximum Length	48	
Minimum Length	1	
EAN-8		
EAN-8	Enabled	
Check Character	Transmit	
2-Digit Add-On Code	Disabled	
5-Digit Add-On Code	Disabled	
Add-On Code	Not Required	
EAN-13		
EAN-13	Enabled	
Check Character	Transmit	
2-Digit Add-On Code	Disabled	
5-Digit Add-On Code	Disabled	
Add-On Code	Not required	
Security Level	1	
UPC-E		
UPC-E	Enabled	
UPC-E0	Enabled	
UPC-E1	Disabled	
Check Character	Transmit	
2-Digit Add-On Code	Disabled	
5-Digit Add-On Code	Disabled	
Add-On Code	Not required	
Transmit Preamble Character	System Character	
Security Level	1	
UPC-A		
UPC-A	Enabled	
Check Character	Transmit	
2-Digit Add-On Code	Disabled	
5-Digit Add-On Code	Disabled	

Add-On Code	Not required	
Transmit Preamble Character	System Character	
Security Level	1	
Interleaved 2 of 5		
Interleaved 2 of 5	Enabled	
Check Character Verification	Disabled	
Maximum Length	80	
Minimum Length	6	
Febraban	Disabled	
Security Level	1	
ITF-14		
ITF-14	Disabled	
Security Level	1	
ITF-6		
ITF-6	Disabled	
Security Level	1	
Matrix 2 of 5		
Matrix 2 of 5	Enabled	
Check Character Verification	Disabled	
Maximum Length	80	
Minimum Length	4	
Security Level	1	
Code 39		
Code 39	Enabled	
Check Character Verification	Disabled	
Start/Stop Character	Do not transmit	
Code 39 Full ASCII	Disabled	
Maximum Length	48	
Minimum Length	1	
Full ASCII	Disabled	
Code 32 Pharmaceutical (PARAF)	Disabled	
Code 32 Prefix	Disabled	
Transmit Code 32 Start/Stop Character	Do not transmit	
Transmit Code 32 Check Character	Do not transmit	
Security Level	1	

Codabar		
Codabar	Enabled	
Check Character Verification	Disabled	
Start/Stop Character	Do not transmit ABCD/ABCD as Start/Stop Character	
Maximum Length	60	
Minimum Length	2	
Security Level	1	
Code 93		
Code 93	Disabled	
Check Character	Do not transmit	
Check Character Verification	Enabled	
Maximum Length	48	
Minimum Length	1	
Security Level	1	
GS1-128 (UCC/EAN-128)		
GS1-128	Disabled	
Maximum Length	48	
Minimum Length	1	
Security Level	1	
GS1 Composite		
GS1 Composite	Disabled	
Enable/Disable UPC/EAN Composite	Disabled	
Output 1D Barcode Only	Disabled	
Security Level	1	
AIM 128		
AIM 128	Disabled	
Maximum Length	48	
Minimum Length	1	
Security Level	1	
ISBT 128		
ISBT 128	Disabled	
Security Level	1	
Code 11		
Code 11	Disabled	
Check Character	Do not transmit	

Check Character Verification	One Check Character, MOD11	
Maximum Length	48	
Minimum Length	4	
Security Level	1	
ISBN		
ISBN	Disabled	
Security Level	1	
ISSN		
ISSN	Disabled	
Security Level	1	
Industrial 25		
Industrial 25	Disabled	
Check Character Verification	Disabled	
Maximum Length	48	
Minimum Length	6	
Security Level	1	
Standard 25		
Standard 25	Disabled	
Check Character Verification	Disabled	
Maximum Length	48	
Minimum Length	6	
Security Level	1	
Plessey		
Plessey	Disabled	
Check Character Verification	Disabled	
Maximum Length	48	
Minimum Length	4	
Security Level	1	
PDF417		
PDF417	Disabled	
PDF417 Inverse	Decode Both	
Character Encoding	Default Character Encoding	
Maximum Length	2710	
Minimum Length	1	
PDF417 ECI Output	Enabled	
Character Encoding	Automatically Select UTF-8 or Code Page	

QR Code		
QR Code	Enabled	
QR Inverse	Read regular & inverse barcodes	
Character Encoding	Automatically Select UTF-8 or Code Page	
QR ECI Output	Enabled	
Maximum Length	7089	
Minimum Length	1	
QR ECI Output	Enabled	
Website QR Code	Enabled	
Data Matrix		
Data Matrix	Enabled	
Rectangular Barcode	Enabled	
Data Matrix Inverse	Read regular & inverse barcodes	
Character Encoding	Automatically Select UTF-8 or Code Page	
Data Matrix ECI Output	Enabled	
Maximum Length	3116	
Minimum Length	1	
Dot-peen Code	Enabled	
Mirror Code	Enabled	
Micro QR		
Micro QR	Enabled	
Maximum Length	35	
Minimum Length	1	
Aztec		
Aztec	Disabled	
Maximum Length	1	
Minimum Length	3832	
Aztec Inverse	Read regular & inverse barcodes	
Character Encoding	Automatically Select UTF-8 or Code Page	
Aztec ECI Output	Enabled	
Prefix & Suffix		
All Prefixes/Suffixes	Enabled	
Prefix Sequence	Code ID+ Custom +AIM ID	
Custom Prefix	Disabled	
AIM ID Prefix	Disabled	
Code ID Prefix	Disabled	

Custom Suffix	Disabled	
Terminating Character Suffix	Enabled	

AIM ID Table

Symbology	AIM ID	Possible AIM ID Modifiers (m)
Code 128]C0	
GS1-128 (UCC/EAN-128)]C1	
GS1 Composite]em	
EAN-8]E4	
EAN-8 with Addon]E3	
EAN-13]E0	
EAN-13 with Addon]E3	
UPC-E]E0	
UPC-E with Addon]E3	
UPC-A]E0	
UPC-A with Addon]E3	
Interleaved 2 of 5]Im	0, 1, 3
ITF-14]Im	1, 3
ITF-6]Im	1, 3
Matrix 2 of 5]X0	
Code 39]Am	0, 1, 3, 4, 5, 7
Codabar]Fm	0, 2, 4
Code 93]G0	
ISSN]X0	
ISBN]X0	
Industrial 25]S0	
Standard 25]R0	
AIM 128]C2	
Plessey]P0	
Code 11]Hm	0, 1, 3
ISBT 128]C4	
PDF417]Lm	0-2
QR Code]Qm	0-6
Data Matrix]dm	0-6
Micro QR]Q1	
Aztec]zm	

Note: “m” represents the AIM modifier character. Refer to ISO/IEC 15424:2008 Information technology – Automatic identification and data capture techniques – Data Carrier Identifiers (including Symbology Identifiers) for AIM modifier character details.

Code ID Table

Symbology	Code ID
Code128	j
GS1-128 (UCC/EAN-128)	j
GS1 Composite	y
EAN-8	d
EAN-13	d
UPC-E	c
UPC-A	c
Interleaved 2 of 5	e
ITF-14	e
ITF-6	e
Matrix 2 of 5	v
Code 39	b
Codabar	a
Code 93	i
AIM 128	X
ISSN	g
ISBT 128	X
Industrial 2/5	l
Standard 2/5	f
Plessey	n
Code 11	H
Aztec	z
PDF417	r
QR Code	s
Data Matrix	u

Symbology ID Number

Symbology	ID Number
Code 128	002
GS1-128 (UCC/EAN-128)	003
EAN-8	004
EAN-13	005
UPC-E	006
UPC-A	007
Interleaved 2 OF 5	008
ITF-14	009
ITF-6	010
Matrix 2 of 5	011
Code 39	013
Codabar	015
Code 93	017
AIM 128	020
ISBT128	021
ISSN	023
Industrial25	025
Standard25	026
Plessey	027
Code11	028
GS1 Composite	030
PDF417	032
QR Code	033
Data Matrix	035
Aztec	034
Micro QR	043

ASCII Table

Hex	Dec	Char
00	0	NUL (Null char.)
01	1	SOH (Start of Header)
02	2	STX (Start of Text)
03	3	ETX (End of Text)
04	4	EOT (End of Transmission)
05	5	ENQ (Enquiry)
06	6	ACK (Acknowledgment)
07	7	BEL (Bell)
08	8	BS (Backspace)
09	9	HT (Horizontal Tab)
0a	10	LF (Line Feed)
0b	11	VT (Vertical Tab)
0c	12	FF (Form Feed)
0d	13	CR (Carriage Return)
0e	14	SO (Shift Out)
0f	15	SI (Shift In)
10	16	DLE (Data Link Escape)
11	17	DC1 (XON) (Device Control 1)
12	18	DC2 (Device Control 2)
13	19	DC3 (XOFF) (Device Control 3)
14	20	DC4 (Device Control 4)
15	21	NAK (Negative Acknowledgment)
16	22	SYN (Synchronous Idle)
17	23	ETB (End of Trans. Block)
18	24	CAN (Cancel)
19	25	EM (End of Medium)
1a	26	SUB (Substitute)
1b	27	ESC (Escape)
1c	28	FS (File Separator)
1d	29	GS (Group Separator)

Hex	Dec	Char
1e	30	RS (Request to Send)
1f	31	US (Unit Separator)
20	32	SP (Space)
21	33	! (Exclamation Mark)
22	34	" (Double Quote)
23	35	# (Number Sign)
24	36	\$ (Dollar Sign)
25	37	% (Percent)
26	38	& (Ampersand)
27	39	` (Single Quote)
28	40	((Left/ Opening Parenthesis)
29	41) (Right/ Closing Parenthesis)
2a	42	* (Asterisk)
2b	43	+ (Plus)
2c	44	, (Comma)
2d	45	- (Minus/ Dash)
2e	46	. (Dot)
2f	47	/ (Forward Slash)
30	48	0
31	49	1
32	50	2
33	51	3
34	52	4
35	53	5
36	54	6
37	55	7
38	56	8
39	57	9
3a	58	: (Colon)
3b	59	; (Semi-colon)
3c	60	< (Less Than)
3d	61	= (Equal Sign)

Hex	Dec	Char
3e	62	> (Greater Than)
3f	63	? (Question Mark)
40	64	@ (AT Symbol)
41	65	A
42	66	B
43	67	C
44	68	D
45	69	E
46	70	F
47	71	G
48	72	H
49	73	I
4a	74	J
4b	75	K
4c	76	L
4d	77	M
4e	78	N
4f	79	O
50	80	P
51	81	Q
52	82	R
53	83	S
54	84	T
55	85	U
56	86	V
57	87	W
58	88	X
59	89	Y
5a	90	Z
5b	91	[(Left/ Opening Bracket)
5c	92	\ (Back Slash)
5d	93] (Right/ Closing Bracket)

Hex	Dec	Char
5e	94	^ (Caret/ Circumflex)
5f	95	_ (Underscore)
60	96	' (Grave Accent)
61	97	a
62	98	b
63	99	c
64	100	d
65	101	e
66	102	f
67	103	g
68	104	h
69	105	i
6a	106	j
6b	107	k
6c	108	l
6d	109	m
6e	110	n
6f	111	o
70	112	p
71	113	q
72	114	r
73	115	s
74	116	t
75	117	u
76	118	v
77	119	w
78	120	x
79	121	y
7a	122	z
7b	123	{ (Left/ Opening Brace)
7c	124	(Vertical Bar)
7d	125	} (Right/ Closing Brace)
7e	126	~ (Tilde)
7f	127	DEL (Delete)

SCANNING MADE SIMPLE

Newland AIDC EMEA
+31 (0) 345 87 00 33
info@newland-id.com

Rolweg 25
4104 AV Culemborg
The Netherlands

